



Construction Recommendations

*Construction examples for
roof, wall, floor and ceiling*



Contents

General information	P. 3
1. Roof	
1.1 Full rafter insulation, new build	P. 6
1.2 On-roof insulation, new build/reconstruction	P. 7
1.3 Common rafter insulation reconstruction, from inside	P. 8
1.4 Common rafter insulation reconstruction, from outside	P. 9
1.4.1 Common rafter insulation reconstruction, from outside/interior panelling PB	P. 10
1.4.2 Common rafter insulation reconstruction, from outside/interior panelling HWL	P. 12
1.4.3 Common rafter insulation reconstruction, from outside/interior panelling for profiled wood formwork	P. 14
1.5 Flat roof	P. 16
2. Wall	
2.1 Timber frame construction	P. 18
2.2 Brickwork reconstruction, from outside	P. 20
2.3 Brickwork reconstruction, from inside	P. 23
2.4 Stud wall reconstruction, from outside/inside	P. 24
2.5 New build brickwork insulation, from outside	P. 26
2.6 Prefabricated house reconstruction	P. 30
2.7 Solid timber element	P. 32
3. Lightweight partition walls	
3.1 Timber upright construction	P. 36
3.2 Metal upright construction	P. 37
4. Concrete ceiling	
4.1 Cement screed	P. 38
4.2 Mastic asphalt	P. 38
4.3 Sill plate/dry screed element	P. 39
4.4 Solid wooden floor	S. 39
5. Beamed ceiling	
Bare ceiling	P. 40
5.1 Cement screed	P. 41
5.2 Mastic asphalt	P. 42
5.3 Sill plate/dry screed element	P. 44
5.4 Solid wooden floor	P. 45
6. Top floor ceiling	
6.1 Concrete ceiling	P. 47
6.2 Beamed ceiling	P. 47

General information

The brochure below entitled "*Construction Recommendations*" provides a summary of the design examples for roof, wall, floor and ceiling, with the relevant structural values for the protection against cold winter temperatures, hot summer temperatures, noise and fire. All constructions are calculated in accordance with DIN 4108 and hence tested for diffusion, moisture and condensate.

Insulation against the cold in winter



Thanks to their low thermal conductivity, GUTEX wood fibreboard insulation products provide outstanding protection against low winter temperatures and heat. They counteract thermal loss and inhibit the rapid cooling of living space.

The benefits of thermal insulation?

- Enhance living comfort through higher wall surface temperatures etc.
- Improve the room conditions
- Saves energy and hence cuts heating costs
- Protects our environment by considerably reducing CO₂ emissions
- Increasing the building's value (energy certificate)

Requirements for component reconstruction

Component	U-factor (W/m ² K)	
	Specification GEG 2020	kfw-individual measures
Exterior wall	≤ 0.24	≤ 0.20
Exterior wall insulation, from inside	≤ 0.35	≤ 0.33
Steep roof	≤ 0.24	≤ 0.14
Flat roof	≤ 0.20	≤ 0.14
Top floor ceiling	≤ 0.24	≤ 0.14

Recommendations for new build

For new build, the entire building envelope and the building technology is considered from an energy perspective as an integrated unit.

Component	U-factor (W/m ² K)	
	Recommendation	Visionary
Exterior wall	≤ 0.16	≤ 0.12
Steep roof/top floor ceiling	≤ 0.16	≤ 0.12
Flat roof	≤ 0.14	≤ 0.12

The result is a comprehensive work of reference, which considerably simplifies component planning. To create a failure-free construction, the manufacturer's data and/or the installation instructions for all materials used must be observed.

Insulation against the heat in summer



To prevent the living areas, especially those below the roof, from overheating, the thermal capacity of the insulating material used must dampen and delay the thermal flow from outside to inside. Because, with a specific thermal capacity of 2100 J/kgK, wood has the highest thermal capacity of all building materials, GUTEX wood fibreboard insulation products provide excellent protection against hot summer temperatures.

Example

Insulation with 180 mm GUTEX Thermosafe-homogen[®] offers a phase shift (delay) of 10.0 hours. If the ambient air temperature fluctuates by 21°C, as depicted in the diagram, the interior air fluctuation is 3°C (amplitude damping = 7).

How can we realise protection against summer temperatures? As well as the known structural influences such as position and size of the windows, air and wind tightness of the building and rear-ventilated construction, the choice of insulating material is key to summer temperature protection.

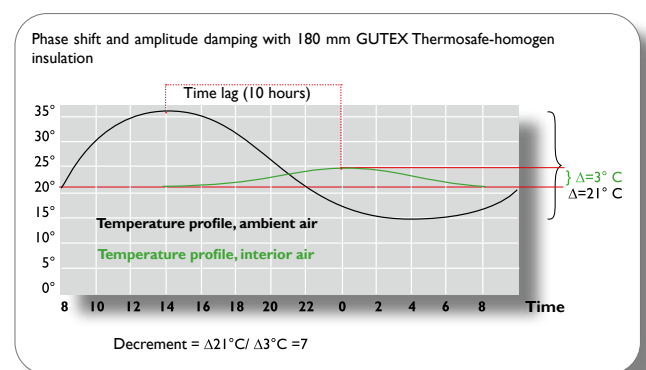

General information

Acoustic insulation



The requirements and recommendations are defined in DIN 4109. Components are supposed to dampen and/or minimise the noise outside and inside the building. For noise protection, a distinction is drawn between airborne noise and impact noise. Airborne noise protection is relevant for wall and roof components, impact noise protection for floor and ceiling constructions.

Airborne noise protection:

The specific variable is the airborne noise factor R in dB. The higher the singular value, the more effective the airborne noise insulation. The characteristics of high raw density, low flexural strength and porous fibre structure exhibited by GUTEX fibreboard insulation products guarantee a high degree of noise absorption and hence optimised noise protection!

Airborne noise protection:

The specific variable is the impact noise insulation factor L in dB. The lower the singular value, the more effective the impact noise insulation. Board characteristics essential to impact noise protection are weight, flexural strength, dynamic strength and decoupling. For noise insulation, a distinction is drawn between noise transmission through the component with and without byways.

Requirements and recommendations

Exterior wall/steep roof:

Requirements for the airborne noise insulation of exterior components

Noise level range	Significant outside noise level	Wards in infirmaries	Common rooms in apartments etc.	Offices etc. ¹⁾
	dB (A)	emp. $R'_{w,RES}$ of the structural part in dB		
I	up to 55	35	30	
II	55 - 60	35	30	30
III	61 - 65	40	35	30
IV	66 - 70	45	40	35
V	71 - 75	50	45	40
VI	76 - 80	²⁾	50	45
VII	> 80	²⁾	²⁾	50

¹⁾ No requirements are placed on exterior components of exterior rooms, where the penetrating outside noise, due to the activities being carried out inside the rooms, make only a secondary contribution to the inside noise level.

²⁾ The requirements must be set out here on account of the local conditions.

Correction values for the requisite noise insulation factor $R'_{w,RES}$ of the exterior component depending on the condition of the component surface

$S_{(W+F)}$ for the ground area of the room $S_{(G)}$

$S_{(W+F)} / S_{(G)}$	2.5	2.0	1.6	1.3	1.0	0.8	0.6	0.5	0.4
Correction value	+5 dB	+4 dB	+3 dB	+2 dB	+1 dB	0 dB	-1 dB	-2 dB	-3 dB

Semi-detached houses and terraced houses	emp. R'_{w} (dB)
Recommendations for improved noise protection	Partition walls 57

Floor:

Recommendations for the noise protection of ceilings within the dwelling		
	Airborne noise	Impact noise
for standard noise protection	R'_{w} 50 dB	$L'_{n,w}$ 57 dB
for improved noise protection	R'_{w} 55 dB	$L'_{n,w}$ 46 dB

Requirements and recommendations for the noise protection partition ceilings in apartment buildings		
	Airborne noise	Impact noise
from DIN 4109	R'_{w} 54 dB	$L'_{n,w}$ 53 dB
for improved noise protection from supplement 2 DIN 4109	R'_{w} 55 dB	$L'_{n,w}$ 46 dB

Interior walls:

Requisite airborne noise insulation for protection against noise transmission from an external living and working area

Components	emp. R'_{w} in dB
Multi-story buildings with apartments and offices	
Partition walls and walls between external work areas	53
Staircase walls and walls next to the building corridors	52
Walls next to thoroughfares	55
In hospitals: - Walls between patients' rooms - Corridors and patients' rooms - Examination rooms - Consultation rooms	47
Schools: walls between classrooms	47
Walls between classrooms and staircases	52

Pleasant indoor environment



GUTEX wood fibreboard insulation products are permeable ($\mu = 3$) and control air humidity by absorbing and subsequently emitting up to 15 %, depending on the room conditions, of the board weight in humidity, without losing the insulating effect. The combination of these two characteristics positively effects the room conditions.

Fire protection



GUTEX understands fire safety as protection for people and animals against fire. Fire safety, however, also means minimising the resultant damage.

The requirements for building fire safety are regulated by the countries concerned. There are two distinctly different requirements. One is the building material class or its fire behaviour and the other is the fire resistance class of a component. Building material classes or fire behaviour fall into classes A = "non-flammable" to F = "highly-flammable".

For the construction industry, however, the minimum requirement is Class B2 = "normally flammable" (Germany) or Class E = "normally flammable" (Europe). Testing institutes conduct flammability tests on building productions and classify them accordingly.

Fire resistance falls into classes F 30 – F180. The classification is in turn carried out by testing institutes and the product is certified accordingly. In this case, it is not the product that is classified but an entire component. F 30 means, for example, that a component will withstand fire for 30 minutes without structural failure or burn through. This guarantees that a construction in this category offers, in case of fire, 30 minutes to move people and animals out of the hazard zones.

Fire safety structures

Various components are classified in the AbPs (general building inspection certificates) below.

The numerous structural variants simplifies planning procedures and the associated fulfillment of fire safety requirements.

AbP P-SAC 02/III-370:

On-roof insulation and **common rafter insulation** in fire resistance classes F30-B to F90-B with GUTEX Thermosafe-homogen, GUTEX Thermoflex® and GUTEX Multiplex-top®/Ultratherm®.

AbP P-SAC 02/III-321:

Supporting, enclosing **exterior wall** in fire resistance classes F30-B to F90-B with GUTEX Thermowall/-gf® and GUTEX Multiplex-top®/Ultratherm®.

AbP P-172 34405-ift:

Partition wall in class F90-B and a noise protection requirement of min. $R_w = 57$ dB.

Recyclability



GUTEX wood fibreboard is recyclable and can, unless contaminated by wood preservatives, be returned for reuse.

Environmental compatibility



In the case of an ecological insulating material, the principle of sustainability over the entire life cycle, from production to processing and use, through to disposal should be the top priority.

All trees bind, during their lifetime, the same amount of CO₂, which they emit into the environment when they rot or are burned. Because GUTEX soft board is made from woodchip that occurs as a byproduct in the saw mill, it contains CO₂, which is not emitted into the atmosphere as a greenhouse gas. GUTEX obtains the woodchip from the saw mills surrounding its Waldshut-Tiengen site in the south of the Black Forest. Other plus factors in the eco-balance are wood from sustainable forests and short supplier transport routes. Unless contaminated by foreign material, GUTEX softboard can be recycled at the end of its utilisation pathway.

GUTEX products carry the quality mark "natureplus". The tough criteria that have to be met for the "natureplus" to be awarded are reviewed annually by the umbrella association of environmental organisations, institutes, construction biologists, companies and associations. The basic criteria for the award are

- high technical product quality
- completely harmless to health
- environmentally compatible production
- sustainability of the raw materials used

User friendly



GUTEX insulating board exhibits extremely narrow dimensional tolerances and is produced to tough quality standards. This, coupled with detailed instructions makes for simple processing.

Made in Germany



For almost 80 years now, "GUTEX Holzfaserplattenwerk", a family-owned enterprise based in the Black Forest has been producing wood fibreboard insulation products at its Waldshut-Tiengen plant in the south of the area. All GUTEX insulating board carries the CE and Ü marks is produced to the specified standard. The composite thermal insulation system from GUTEX is also approved by the building authorities.

I. Roof

I.1 Full rafter insulation new build

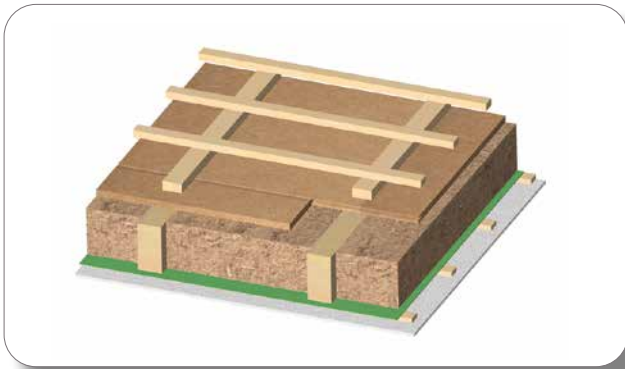

I.1.1

Structure:

- Tile battens
- Counter battens
- **GUTEX Multiplex-top®**
- **GUTEX Thermofibre®/GUTEX Thermoflex®** between the rafters
- Vapour barrier/air seal
- Battens
- Facing

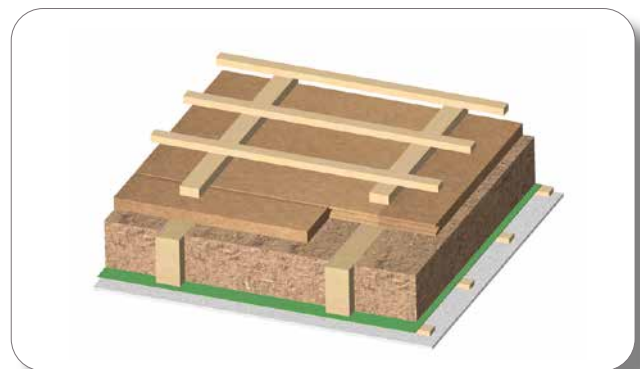

I.1.2

Structure:

- Tile battens
- Counter battens
- **GUTEX Ultratherm®**
- **GUTEX Thermofibre®/GUTEX Thermoflex®** between the rafters
- Vapour barrier/air seal
- Battens
- Facing

GUTEX Multiplex-top® (mm)	GUTEX Thermofibre®/ Thermoflex® (mm)	U-factor (W/m²K) ¹⁾	Phase shift (h)	Noise insulation value R _{w,R} (dB) ²⁾
22	180	0.22	9.5	48
	200	0.20	10.2	47
	220	0.18	11.0	
	240	0.17	11.7	
28	180	0.21	10.0	48
	200	0.19	10.7	49
	220	0.18	11.4	
	240	0.17	12.1	
35	180	0.20	10.5	47
	200	0.19	11.2	48
	220	0.17	11.9	
	240	0.16	12.7	

GUTEX Ultratherm® (mm)	GUTEX Thermofibre®/ Thermoflex® (mm)	U-factor (W/m²K) ¹⁾	Phase shift (h)	Noise insulation value R _{w,R} (dB) ²⁾
50	180	0.19	11.6	46
	200	0.17	12.3	
	220	0.16	13.1	
	240	0.15	13.8	
60	180	0.18	12.4	47
	200	0.17	13.1	
	220	0.16	13.8	
	240	0.15	14.6	
80	180	0.16	13.9	48
	200	0.15	14.6	
	220	0.14	15.3	
	240	0.14	16.1	
100	180	0.15	15.3	49
	200	0.14	16.0	
	220	0.13	16.8	
	240	0.13	17.5	
120	180	0.14	16.7	50
	200	0.13	17.4	
	220	0.13	18.1	
	240	0.12	18.9	
140	180	0.13	18.1	50
	200	0.13	18.8	
	220	0.12	19.5	
	240	0.11	20.2	
160	180	0.12	19.4	50
	200	0.12	20.2	
	220	0.11	20.9	
	240	0.11	21.6	

1) Calculation with 10 % wood content

2) The noise levels refer to a construction with GUTEX Thermoflex, a roof covering with concrete roofing tiles and double-threaded bolt fastening

I. Roof

I.2 On-roof insulation, new build/reconstruction

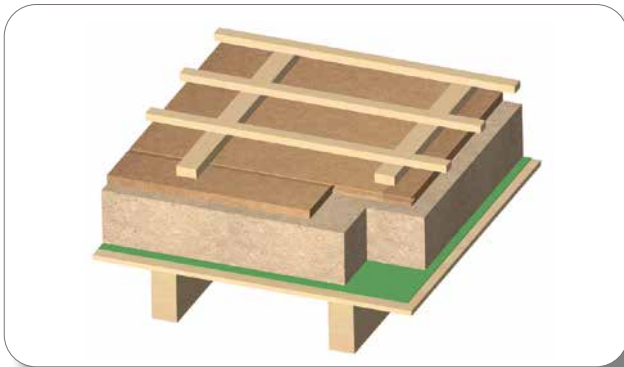

1.2.1

Structure:

- Tile battens
- Counter battens
- **GUTEX Multiplex-top/GUTEX Ultratherm**
- **GUTEX Thermosafe-homogen**
- Vapour barrier/air seal
- Exposed formwork 24 mm
- Exposed rafters

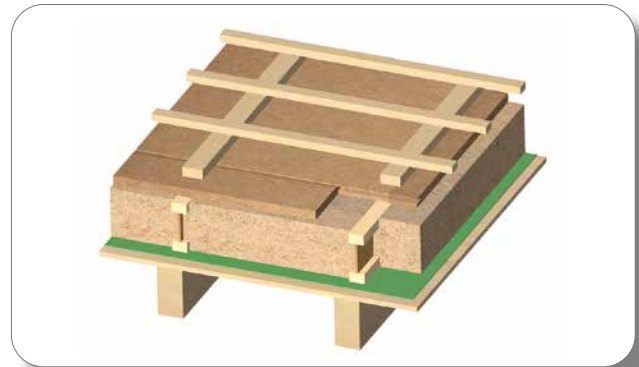

1.2.2

Structure:

- Tile battens
- Counter battens
- **GUTEX Multiplex-top®/GUTEX Ultratherm®**
- **GUTEX Thermofibre®** between double I-joists
- Vapour barrier/air seal
- Exposed formwork 24 mm
- Exposed rafters

	Thick-ness (mm)	GUTEX Thermosafe-homogen (mm)	U-factor ¹⁾ (W/m ² K)	Phase shift (h)	Noise insulation value R _{w,R} (dB) ²⁾
GUTEX Multiplex-top	18	140	0.22	11.7	46
		160	0.20	12.9	46
		180	0.18	14.0	47
		200	0.16	15.2	47
		220	0.15	16.4	48
		240	0.14	17.5	48
	22	140	0.22	12.0	46
		160	0.19	13.2	46
		180	0.18	14.3	47
		200	0.16	15.5	47
		220	0.15	16.6	48
		240	0.14	17.8	48
	28	200	0.16	15.9	47
		220	0.14	17.1	48
240		0.13	18.2	48	
35	200	0.15	16.4	47	
	220	0.14	17.6	48	
	240	0.13	18.7	48	
GUTEX Ultratherm	50	200	0.14	17.5	46
		220	0.13	18.6	48
		240	0.12	19.8	48
	60	200	0.14	18.2	46
		220	0.13	19.4	48
		240	0.12	20.5	48
	80	200	0.13	19.7	46
		220	0.12	20.8	48
		100	200	0.12	21.1

	Thick-ness (mm)	GUTEX Thermofibre® (mm)	U-factor ¹⁾ (W/m ² K)	Phase shift (h)	
GUTEX Multiplex-top®	28	200	0.17	10.8	
		220	0.15	11.4	
		240	0.14	12.0	
	35	200	0.16	11.3	
		220	0.15	11.9	
		240	0.14	12.6	
GUTEX Ultratherm®	60	200	0.15	12.5	
		220	0.14	13.1	
		240	0.13	13.7	
		200	0.15	13.3	
		220	0.14	13.9	
		240	0.13	14.5	
	80	200	0.14	14.8	
		220	0.13	15.4	
		240	0.12	16.0	
		100	200	0.13	16.2
			220	0.12	16.8
			240	0.11	17.5

1) Calculation with 10 % wood content

2) The noise levels refer to a construction with GUTEX Thermoflex, a roof covering with concrete roofing tiles and double-threaded bolt fastening

I. Roof

I.3 Reconstruction, from inside

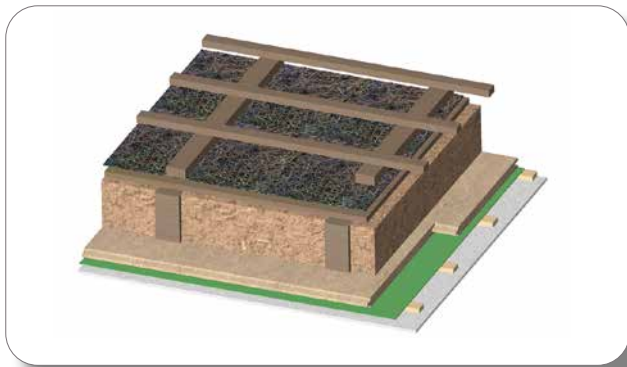

I.3.1 Common rafter insulation

Structure:

- Existing tile battens
- Existing counter battens
- Existing formwork with bitumen sheeting 26 mm
- **GUTEX Thermofibre®/GUTEX Thermoflex®** between the rafters
- **GUTEX Multitherm®** with groove and spring
- Vapour barrier/air seal, moisture variable
- Battens
- Facing

GUTEX Multitherm® (mm)	GUTEX Thermofibre®/ Thermoflex® (mm)	U-factor (W/m²K) ¹⁾	Phase shift (h)	Noise insulation value R _{w,R} (dB) ²⁾
20	160	0.23	9.8	≤ 49
	180	0.21	10.5	
40	140	0.22	10.2	
	160	0.20	10.9	
	180	0.19	11.6	
	200	0.17	12.3	
60	120	0.22	10.7	
	140	0.20	11.4	
	160	0.18	12.1	
	180	0.17	12.8	
	200	0.16	13.5	
80	120	0.20	11.9	
	140	0.18	12.6	
	160	0.17	13.3	
	180	0.16	14.0	
	200	0.15	14.8	
100	120	0.18	13.2	
	140	0.16	13.9	
	160	0.15	14.6	
	180	0.14	15.3	
	200	0.14	16.0	
120	120	0.16	14.5	
	140	0.15	15.2	
	160	0.14	15.9	
	180	0.13	16.6	
	200	0.13	17.3	

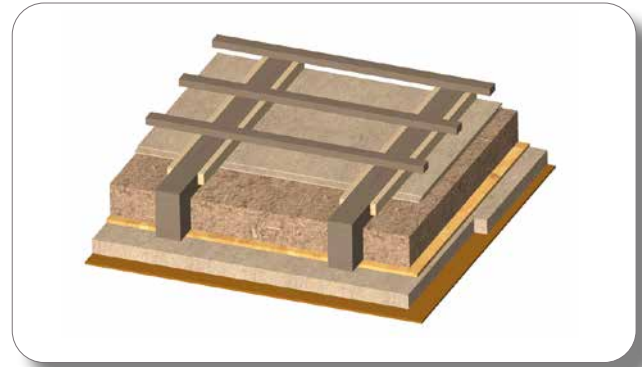

I.3.2 Common rafter insulation

Structure:

- Existing tile battens
- Battens on rafters
- **GUTEX Multiplex-top®** 22 mm between the rafters
- **GUTEX Thermofibre®/GUTEX Thermoflex®** between the rafters
- OSB board 15 mm
- **GUTEX Thermoroom®**
- Loam rendering layer 15 mm

GUTEX Thermoroom® (mm)	GUTEX Thermofibre®/ Thermoflex® (mm)	U-factor ¹⁾ (W/m²K)	Phase shift (h)	Noise insulation value R _{w,R} (dB) ²⁾
40	120	0.23	12.5	46
	140	0.21	13.2	
	160	0.19	13.9	
	180	0.17	14.6	
	200	0.16	15.3	
60	100	0.22	13.2	
	120	0.20	13.8	
	140	0.19	14.4	
	160	0.17	15.1	
	180	0.16	15.8	
	200	0.15	16.6	
80	80	0.22	13.7	
	100	0.20	14.3	
	120	0.18	15.0	
	140	0.17	15.6	
	160	0.16	16.3	
	180	0.15	17.0	
100	200	0.14	17.7	
	80	0.19	14.9	
	100	0.18	15.5	
	120	0.17	16.1	
	140	0.15	16.8	
	160	0.14	17.5	
	180	0.14	18.2	
200	0.13	18.9		

Note: A building physics proof is required for this construction.

1) Calculation with 10 % wood content

2) Values as per "Informationsdienst Holz", series 3, part 3, sequence 4, R_{w,R} = calculated value, incl. allowance

I. Roof

I.3 Reconstruction, from inside/ I.4 Reconstruction, from outside

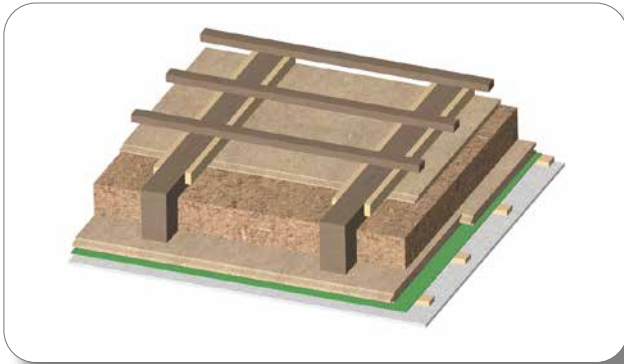

I.3.3 Common rafer insulation

Structure:

- Existing tile battens
- Battens on rafters
- **GUTEX Multiplex-top®** 22 mm
- **GUTEX Thermofibre®/GUTEX Thermoflex®** between the rafters
- **GUTEX Multitherm®** with groove and spring
- Vapour barrier/air seal
- Battens
- Facing

GUTEX Multitherm® (mm)	GUTEX Thermofibre®/ Thermoflex® (mm)	U-factor ¹⁾ (W/m²K)	Phase shift (h)	Noise insulation value R _{v,R} (dB) ²⁾
40	120	0.23	9.5	≤ 47
	140	0.21	10.1	
	160	0.19	10.8	
	180	0.18	11.6	
	200	0.17	12.3	
60	100	0.23	10.0	
	120	0.21	10.6	
	140	0.19	11.3	
	160	0.18	12.0	
	180	0.16	12.8	
80	200	0.15	13.5	
	80	0.22	10.6	
	100	0.20	11.2	
	120	0.19	11.9	
	140	0.17	12.6	
	160	0.16	13.3	
100	180	0.15	14.0	
	200	0.14	14.7	
	80	0.20	11.8	
	100	0.18	12.5	
	120	0.17	13.2	
	140	0.16	13.8	
120	160	0.15	14.6	
	180	0.14	15.3	
	200	0.13	16.0	
	80	0.18	13.1	
	100	0.17	13.7	
	120	0.16	14.4	
	140	0.15	15.1	
	160	0.14	15.8	
	180	0.13	16.6	
	200	0.12	17.3	

1) Calculation with 10 % wood content

2) Values as per "Informationsdienst Holz", series 3, part 3, sequence 4, R_{v,s} = calculated value, incl. allowance

I.4 Reconstruction, from outside

Important information:

GUTEX systematic roof reconstruction

The following reconstruction variants from outside can be executed only using the membranes from the following GUTEX system partners:

- **Proclima**, membranes *Solitex UD*, *Solitex UD connect* (0,06*) and *DASAPLANO 0,01 connect* (0,02*)
- **Ampack**, membrane *Ampack Ampatex LDA 0,02 plus* (0,02*)
- **Isocell**, membranes *OMEGA MONO 200* (0,10*) and *OMEGA LIGHT* (0,02*)
- **CaPlast**, membranes *CaTop M 170* (0,04*) and *CaTop M 120* (0,04*)
- **Förch**, membrane *Saniflex 002* (0,02*)
- **Saint Gobain**, membranes *ULTIPro UDB 310/-SK* (0,02*) and *ULTIPro UDB 210/-SK* (0,02*)
- **BWK**, membranes *DIFFLEX Thermo ND* (0,09*), *REWASI TOP 130 UV+* (0,02*) and *REWASI TOP 150 UV+* (0,06*)
- **Alujet**, membranes *JKE Basic* (0,02*) und *JKE Professional* (0,02*)
- **Dörken**, membrane *DELTA-XX PLUS UNIVERSAL*** (0,08*)
- **Wienerberger**, membranes *Koramic Classic 2S* (0,02*) and *Koramic Profi 2S* (0,03*)
- **Würth**, membrane *Wüttop PP Plus 150* (0,1*)
- **SIGA**, membrane *Majcoat 200 SOB* (0,085*)
- **Butler macht's!**, membrane *BM-U 145sk+* (0,03*)
- **Riwega**, membranes *USB Classic light* (0,07*) and *DO 180 top stream* (0,04*)
- **Synwer**, membranes *Head SL 155* (0,07*) and *Head J 170* (0,02*)
- **Knauf Insulation**, membrane *LDS 0,04* (0,04*)
- **BTI**, membrane *Klima Robust SK* (0,02*)
- **BMI Braas**, membranes *Divoroll Kompakt 2S* (0,03*) and *Divoroll Top RU* (0,03*)
- **Meisterling**, membrane *Meisterling „Das Brett“ 3D – UV PLUS* (0,03*)

* sd-value [m] as at 05/2023

Please consider the current data of the respective manufacturers guidelines.

** A separate, coordinated release document from Dörken is available for the product DELTA-XX PLUS UNIVERSAL. For further information, please contact our application technology department.

The insulation thickness ratios described in the relevant tables must be respected.

When using air-tight interior panelling, the air-tight membrane is not required.

I. Roof

I.4.1 Reconstruction, from outside

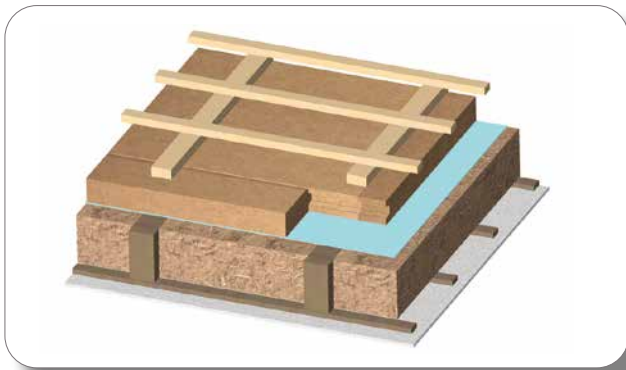

I.4.1.1 Internal panelling, plasterboard

Structure:

- Tile battens
- Counter battens
- **GUTEX Ultratherm®**
- Air-tight membrane in accordance with GUTEX system partner
- **GUTEX Thermofibre®³⁾/GUTEX Thermoflex®** between the rafters
- Existing battens
- PB/PF 12.5 mm

GUTEX Ultratherm® (mm)	GUTEX Thermofibre®/ Thermoflex® (mm)	U-factor (W/m ² K) ¹⁾	Phase shift (h)	Noise insulation value R _{w,R} (dB) ²⁾
50	140	0.22	10.2	≤ 47
	160	0.20	10.9	
	180	0.19	11.6	
	200	0.17	12.3	
60	120	0.23	10.3	≤ 47
	140	0.21	11.0	
	160	0.19	11.7	
	180	0.18	12.4	
	200	0.17	13.1	
80	120	0.21	11.8	≤ 47
	140	0.19	12.5	
	160	0.18	13.2	
	180	0.16	13.9	
	200	0.15	14.6	
100	120	0.19	13.2	≤ 48
	140	0.18	13.9	
	160	0.16	14.6	
	180	0.15	15.3	
	200	0.14	16.0	
120	120	0.17	14.6	≤ 49
	140	0.16	15.3	
	160	0.15	16.0	
	180	0.14	16.7	
	200	0.13	17.4	
140	120	0.16	15.9	≤ 49
	140	0.15	16.6	
	160	0.14	17.4	
	180	0.13	18.1	
	200	0.13	18.8	
160	120	0.15	17.3	≤ 50
	140	0.14	18.0	
	160	0.13	18.7	
	180	0.12	19.4	
	200	0.12	20.2	

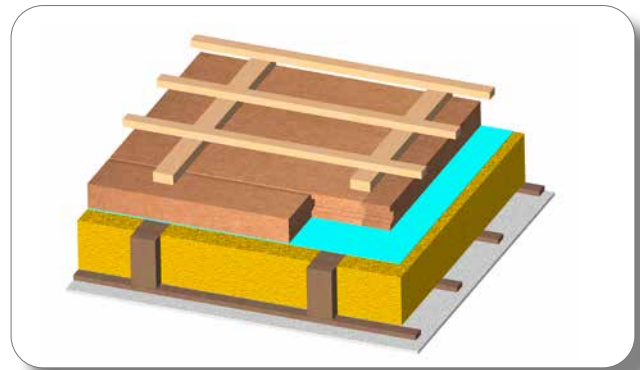

I.4.1.2 Interior panelling, plasterboard

Structure:

- Tile battens
- Counter battens
- **GUTEX Ultratherm®**
- Air-tight membrane* in accordance with GUTEX system partner
- Mineral wool 035 between the rafters
- Existing battens
- PB/PF 12.5 mm

GUTEX Ultratherm® (mm)	Mineral wool 035 (mm)	U-factor (W/m ² K) ¹⁾	Phase shift (h)	Noise insulation value R _{w,R} (dB) ²⁾
50	120	0.24	8.1	≤ 47
	140	0.22	8.9	
60	140	0.20	9.2	≤ 47
	160	0.18**	9.6	
80	120	0.20	10.4	≤ 47
	140	0.18	10.8	
	160	0.17	11.2	
	180	0.16**	11.5	
100	120	0.18	11.9	≤ 48
	140	0.17	12.3	
	160	0.16	12.6	
	200	0.14**	13.3	
120	120	0.17	13.3	≤ 49
	140	0.16	13.6	
	160	0.15	14.0	
	200	0.13	14.7	
140	120	0.16	14.6	≤ 49
	140	0.15	15.0	
	160	0.14	15.4	
	180	0.13	15.7	
160	200	0.12	16.1	≤ 50
	120	0.15	16.0	
	140	0.14	16.4	
	160	0.13	16.7	
	180	0.12	17.1	
	200	0.11	17.4	

*Note: With this construction, the sd-value for the air-tight membrane must not exceed 0.03m.

**In these constructions, additional measures, for example insertion of a vapor barrier strip between the rafters must be taken

1) Calculation with 10 % wood content

2) Values as per "Informationsdienst Holz", series 3, part 3, sequence 4, R_{w,R} = calculated value, incl. allowance

3) When using GUTEX Thermofibre, air-tight interior panelling must be produced

I. Roof

I.4.1 Reconstruction, from outside

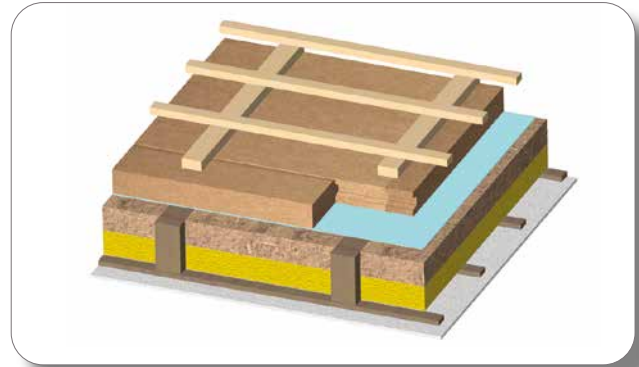
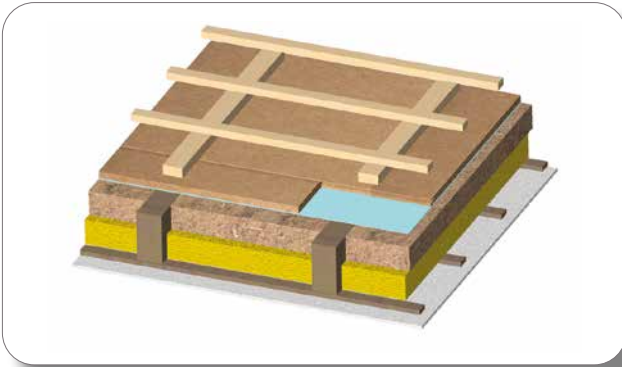

I.4.1.3 Interior panelling, plasterboard

Structure:

- Tile battens
- Counter battens
- **GUTEX Multiplex-top®/ Ultratherm®**
- Air-tight membrane in accordance with GUTEX system partner
- **GUTEX Thermoflex®** between the rafters
- Existing mineral wool with aluminium lining
- Existing battens
- PB/PF 12.5 mm

I.4.1.4 Internal panelling, plasterboard

Structure:

- Tile battens
- Counter battens
- **GUTEX Ultratherm®**
- Air-tight membrane in accordance with GUTEX system partner
- **GUTEX Thermoflex®** between the rafters
- Existing mineral wool with aluminium lining
- Existing battens
- PB/PF 12.5 mm

U-factor in (W/m²K)¹⁾, phase shift in hours (h)

Existing MW WLZ 040 (mm)	GUTEX Thermoflex® (mm)	GUTEX Multiplex-top® (mm)	GUTEX Ultratherm® (mm)			
		35	50	60	80	
60	60	0.28	0.25	0.24	0.21	
		7.6	8.7	9.5	11.0	
	80	0.25	0.23	0.21	0.19	
		8.3	9.4	10.2	11.7	
		0.23	0.21	0.20	0.18	
100	9.0	10.1	10.9	12.4		
	0.21	0.19	0.18	0.17		
80	40	0.28	0.25	0.24	0.21	
		7.2	8.3	9.1	10.6	
	60	0.25	0.23	0.22	0.19	
		7.9	9.1	9.8	11.3	
		0.23	0.21	0.20	0.18	
80	8.7	9.8	10.6	12.1		
	0.21	0.19	0.18	0.17		
100	40	0.25	0.23	0.22	0.20	
		7.5	8.7	9.5	11.0	
	60	0.23	0.21	0.20	0.18	
		8.2	9.4	10.2	11.7	
		0.21	0.19	0.18	0.17	
80	9.0	10.1	10.9	12.4		
	0.19	0.18	0.17	0.16		
120	40	0.23	0.21	0.20	0.18	
		7.8	9.0	9.8	11.3	
	60	0.21	0.19	0.18	0.17	
		8.5	9.7	10.5	12.0	
		0.19	0.18	0.17	0.16	
80	9.3	10.4	11.2	12.7		

U-factor in (W/m²K)¹⁾, phase shift in hours (h)

Existing MW WLZ 040 (mm)	GUTEX Thermoflex® (mm)	GUTEX Ultratherm® (mm)			
		100	120	140	160
60	60	0.19	0.18	0.16	0.15
		12.4	13.8	15.2	16.5
	80	0.18	0.16	0.15	0.14
		13.1	14.5	15.9	17.2
		0.16	0.15	0.14	0.13
100	13.8	15.2	16.6	18.0	
	0.15	0.14	0.13	0.13	
80	40	0.19	0.18	0.16	0.15
		12.1	13.4	14.8	16.2
	60	0.18	0.16	0.15	0.14
		12.8	14.1	15.5	16.9
		0.17	0.15	0.14	0.13
80	13.5	14.9	16.2	17.6	
	0.15	0.14	0.13	0.13	
100	40	0.18	0.16	0.15	0.14
		12.4	13.8	15.2	16.5
	60	0.17	0.15	0.14	0.13
		13.1	14.5	15.9	17.2
		0.15	0.14	0.13	0.13
80	13.8	15.2	16.6	18.0	
	0.14	0.14	0.13	0.12	
120	40	0.17	0.15	0.14	0.13
		12.7	14.1	15.5	16.8
	60	0.15	0.14	0.13	0.13
		13.4	14.8	16.2	17.5
		0.15	0.14	0.13	0.12
80	14.1	15.5	16.9	18.3	

1) Calculation with 10 % wood content

I. Roof

I.4.2 Reconstruction, from outside

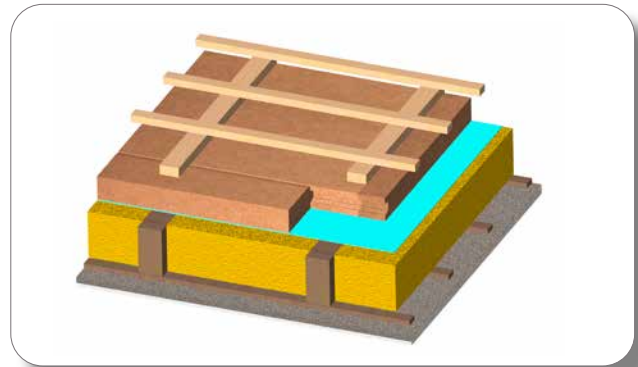
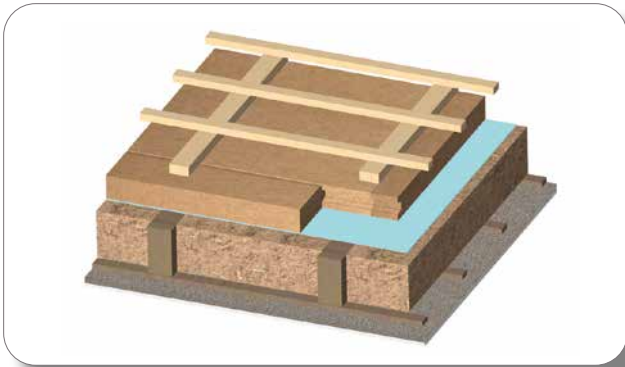

I.4.2.1 Interior panelling HWL board

Structure:

- Tile battens
- Counter battens
- **GUTEX Ultratherm®**
- Air-tight membrane in accordance with GUTEX system partner
- **GUTEX Thermofibre®³⁾/GUTEX Thermoflex®** between the rafters
- Existing battens
- HWL board 25 mm
- Plaster 15 mm

I.4.2.2 Interior panelling HWL board

Structure:

- Tile battens
- Counter battens
- **GUTEX Ultratherm®**
- Air-tight membrane in accordance with GUTEX system partner
- Mineral wool 035 between the rafters
- Existing battens
- HWL board 25 mm
- Plaster 15 mm

GUTEX Ultratherm® (mm)	GUTEX Thermofibre®/ Thermoflex® (mm)	U-factor ¹⁾ (W/m ² K)	Phase shift (h)	Noise insulation value R _{w,R} (dB) ²⁾
50	120	0.23	11.2	≤ 47
	140	0.21	11.9	
	160	0.19	12.6	
	180	0.18	13.3	
	200	0.17	14.0	
60	120	0.22	12.0	≤ 47
	140	0.20	12.7	
	160	0.19	13.4	
	180	0.17	14.1	
	200	0.16	14.8	
80	120	0.20	13.5	≤ 47
	140	0.18	14.2	
	160	0.17	14.9	
	180	0.16	15.6	
	200	0.15	16.3	
100	120	0.18	14.9	≤ 48
	140	0.17	15.6	
	160	0.16	16.3	
	180	0.15	17.0	
	200	0.14	17.7	
120	120	0.17	16.3	≤ 49
	140	0.16	17.0	
	160	0.15	17.7	
	180	0.14	18.4	
	200	0.13	19.1	
140	120	0.15	17.7	≤ 49
	140	0.14	18.3	
	160	0.14	19.0	
	180	0.13	19.7	
	200	0.12	20.5	
160	120	0.14	19.0	≤ 50
	140	0.14	19.7	
	160	0.13	20.4	
	180	0.12	21.1	
	200	0.11	21.8	

GUTEX Ultratherm® (mm)	Mineral wool 035 (mm)	U-factor (W/m ² K) ¹⁾	Phase shift (h)	Noise insulation value R _{w,R} (dB) ²⁾
50	120	0.22	9.6	≤ 47
	140	0.20	9.9	
	160	0.19	10.2	
	180	0.17	10.5	
	200	0.16	10.8	
60	120	0.21	10.5	≤ 47
	140	0.19	10.7	
	160	0.18	11.0	
	180	0.16	11.3	
	200	0.15	11.7	
80	120	0.19	12.0	≤ 47
	140	0.18	12.3	
	160	0.16	12.6	
	180	0.15	12.9	
	200	0.14	13.3	
100	120	0.18	13.5	≤ 48
	140	0.16	13.8	
	160	0.15	14.1	
	180	0.14	14.4	
	200	0.13	14.7	
120	120	0.16	14.9	≤ 49
	140	0.15	15.2	
	160	0.14	15.5	
	180	0.13	15.8	
	200	0.12	16.1	
140	120	0.15	16.2	≤ 49
	140	0.14	16.5	
	160	0.13	16.8	
	180	0.12	17.1	
	200	0.12	17.5	
160	120	0.14	17.6	≤ 50
	140	0.13	17.9	
	160	0.12	18.2	
	180	0.12	18.5	
	200	0.11	18.8	

1) Calculation with 10 % wood content

2) Values in accordance with "Informationsdienst Holz", series 3, part 3, sequence 4, R_{w,s} = calculated value incl. allowance

3) When using GUTEX Thermofibre, air-tight interior panelling must be produced

I. Roof

I.4.2 Reconstruction, from outside

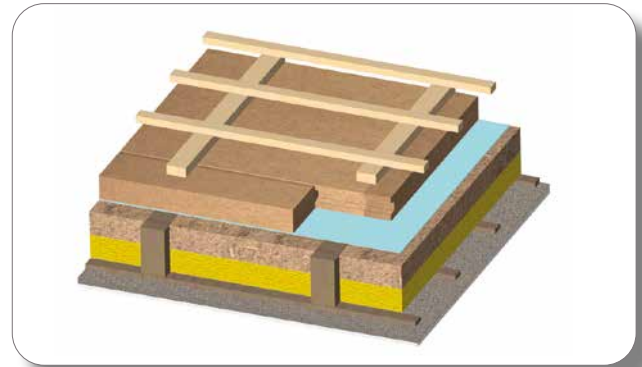
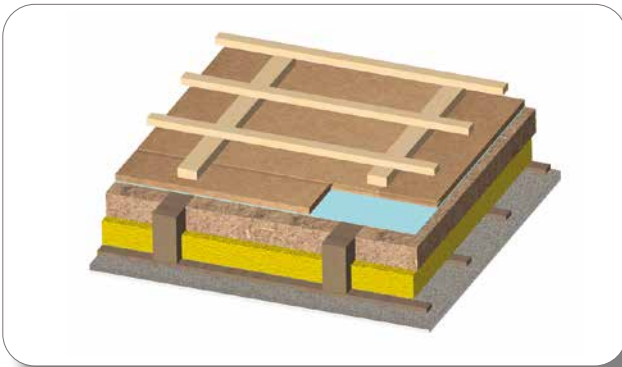

I.4.2.3 Interior panelling HWL board

Structure:

- Tile battens
- Counter battens
- **GUTEX Multiplex-top®/ Ultratherm**
- Air-tight membrane in accordance with GUTEX system partner
- **GUTEX Thermoflex®** between the rafters
- Existing mineral wool with aluminium lining
- Existing battens
- HWL board 25 mm
- Plaster 15 mm

I.4.2.4 Interior panelling HWL board

Structure:

- Tile battens
- Counter battens
- **GUTEX Ultratherm®**
- Air-tight membrane in accordance with GUTEX system partner
- **GUTEX Thermoflex®** between the rafters
- Existing mineral wool with aluminium lining
- Existing battens
- HWL board 25 mm
- Plaster 15 mm

U-factor in (W/m²K)¹⁾, phase shift in hours (h)

Existing MW WLZ 040 (mm)	GUTEX Thermoflex® (mm)	GUTEX Multiplex-top® (mm)	GUTEX Ultratherm® (mm)				
			50	60	80		
80	40	35	0.26	0.24	0.22	0.20	
			8.9	10.0	10.8	12.4	
	60		0.24	0.22	0.20	0.19	
			9.6	10.7	11.5	13.0	
	80		0.21	0.20	0.19	0.17	
			10.3	11.4	12.2	13.7	
	100		0.20	0.18	0.17	0.16	
			11.0	12.1	12.9	14.4	
	120		0.18	0.17	0.16	0.15	
			11.7	12.9	13.6	15.1	
	100	40		0.24	0.22	0.21	0.19
				9.1	10.3	11.1	12.6
60			0.21	0.20	0.19	0.17	
			9.8	11.0	11.8	13.3	
80			0.20	0.18	0.17	0.16	
			10.5	11.7	12.5	14.0	
100			0.18	0.17	0.16	0.15	
			11.3	12.4	13.2	14.7	
120		40		0.22	0.20	0.19	0.17
				9.4	10.5	11.3	12.9
		60		0.20	0.18	0.17	0.16
				10.0	11.2	12.0	13.5
	80		0.18	0.17	0.16	0.15	
			10.6	11.9	12.7	14.2	

U-factor in (W/m²K)¹⁾, phase shift in hours (h)

Existing MW WLZ 040 (mm)	GUTEX Thermoflex® (mm)	GUTEX Ultratherm® (mm)					
		100	120	140	160		
80	40		0.18	0.17	0.16	0.15	
			13.8	15.2	16.6	17.9	
	60		0.17	0.16	0.15	0.14	
			14.4	15.8	17.2	18.6	
	80		0.16	0.15	0.14	0.13	
			15.1	16.5	17.9	19.3	
	100		0.15	0.14	0.13	0.12	
			15.8	17.2	18.6	20.0	
	120		0.14	0.13	0.12	0.12	
			16.6	17.9	19.3	20.7	
	100	40		0.17	0.16	0.15	0.14
				14.0	15.4	16.8	18.2
60			0.16	0.15	0.14	0.13	
			14.7	16.1	17.5	18.8	
80			0.15	0.14	0.13	0.12	
			15.4	16.8	18.2	19.5	
100			0.14	0.13	0.12	0.12	
			16.1	17.5	18.9	20.2	
120		40		0.16	0.15	0.14	0.13
				14.3	15.7	17.0	18.4
		60		0.15	0.14	0.13	0.12
				14.9	16.3	17.7	19.1
	80		0.14	0.13	0.12	0.12	
			15.7	17.0	18.4	19.8	

1) Calculation with 10 % wood content

2) Values as per "Informationsdienst Holz", series 3, part 3, sequence 4, R_{v,s} = calculated value, incl. allowance

I. Roof

I.4.3 Reconstruction, from outside

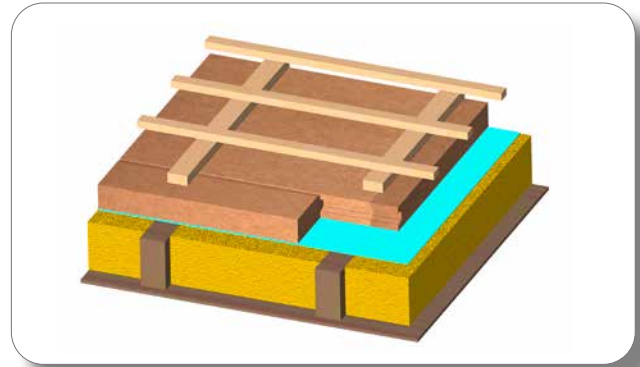
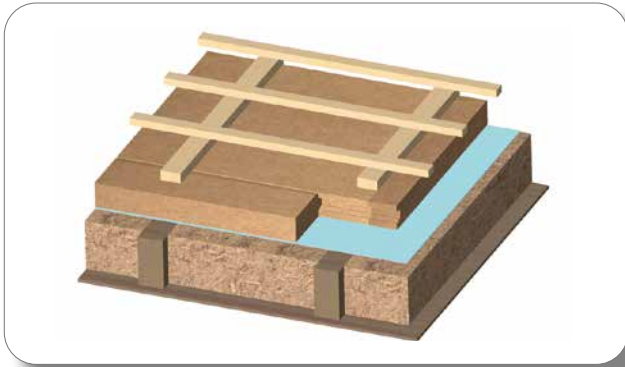

I.4.3.1 Interior panelling, profiled wood formwork

Structure:

- Tile battens
- Counter battens
- **GUTEX Ultratherm®**
- Air-tight membrane in accordance with GUTEX system partner
- **GUTEX Thermofibre®³⁾/GUTEX Thermoflex®** between the rafters
- Profiled wood formwork min. 10 mm

I.4.3.2 Interior panelling, profiled wood formwork

Structure:

- Tile battens
- Counter battens
- **GUTEX Ultratherm®**
- Air-tight membrane in accordance with GUTEX system partner
- Mineral wool 035
- Profiled wood formwork min. 10 mm

GUTEX Ultratherm® (mm)	GUTEX Thermofibre®/ Thermoflex® (mm)	U-factor (W/m²K) ¹⁾	Phase shift (h)	Noise insulation value R _{w,R} dB ²⁾
50	140	0.22	10.7	< 47
	160	0.20	11.4	
	180	0.19	12.2	
	200	0.17	12.9	
60	120	0.23	10.8	< 47
	140	0.21	11.5	
	160	0.19	12.2	
	180	0.18	12.9	
80	120	0.21	12.3	< 47
	140	0.19	13.0	
	160	0.18	13.7	
	180	0.16	14.4	
100	120	0.19	13.7	< 48
	140	0.17	14.4	
	160	0.16	15.1	
	180	0.15	15.9	
120	120	0.17	15.1	< 49
	140	0.16	15.8	
	160	0.15	16.5	
	180	0.14	17.2	
140	120	0.16	16.5	< 49
	140	0.15	17.2	
	160	0.14	17.9	
	180	0.13	18.6	
160	120	0.15	17.9	< 50
	140	0.14	18.6	
	160	0.13	19.3	
	180	0.12	20.0	
	200	0.12	20.7	

GUTEX Ultratherm® (mm)	Mineral wool 035 (mm)	U-factor (W/m²K) ¹⁾	Phase shift (h)	Noise insulation value R _{w,R} dB ²⁾
50	120	0.23	8.6	< 47
	140	0.21	8.9	
	160	0.19	9.2	
	180	0.18	9.6	
60	120	0.22	9.4	< 47
	140	0.20	9.8	
	160	0.18	10.1	
	180	0.17	10.4	
80	120	0.20	11.0	< 47
	140	0.18	11.3	
	160	0.17	11.7	
	180	0.16	12.0	
100	120	0.18	12.4	< 48
	140	0.17	12.8	
	160	0.16	13.1	
	180	0.14	13.4	
120	120	0.17	13.8	< 49
	140	0.15	14.2	
	160	0.14	14.5	
	180	0.14	14.8	
140	120	0.15	15.2	< 49
	140	0.14	15.5	
	160	0.13	15.9	
	180	0.13	16.2	
160	120	0.14	16.6	< 49
	140	0.13	16.9	
	160	0.13	17.2	
	180	0.12	17.6	
	200	0.11	17.9	

1) Calculation with 10 % wood content

2) Values in accordance with "Informationsdienst Holz", series 3, part 3, sequence 4, R_{w,R} = calculated value incl. allowance

3) When using GUTEX Thermofibre, air-tight interior panelling must be produced

I. Roof

I.4.3 Reconstruction, from outside

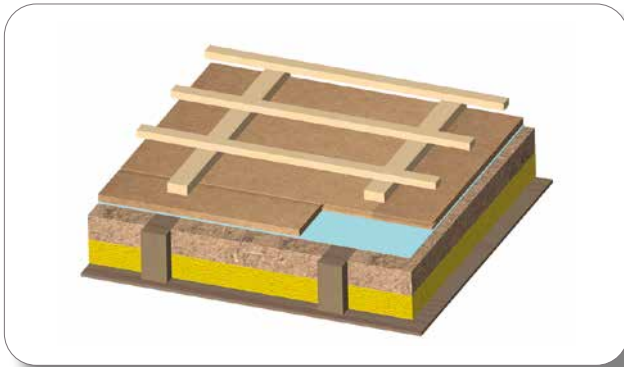

I.4.3.3 Interior panelling, profiled wood formwork

Structure:

- Tile battens
- Counter battens
- **GUTEX Multiplex-top®/ Ultratherm®**
- Air-tight membrane in accordance with GUTEX system partner
- **GUTEX Thermoflex®** between the rafters
- Existing mineral wool with aluminium lining
- Profiled wood formwork min. 10 mm

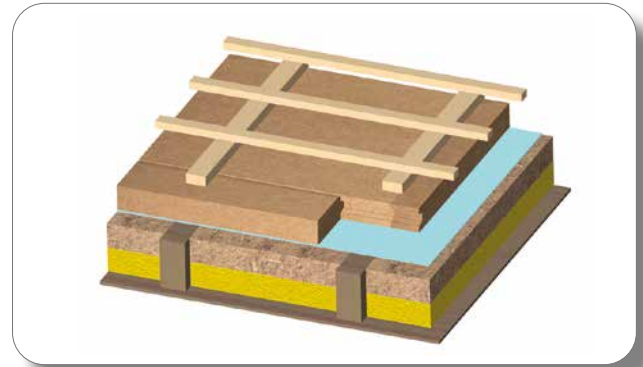

I.4.3.4 Interior panelling, profiled wood formwork

Structure:

- Tile battens
- Counter battens
- **GUTEX Ultratherm®**
- Air-tight membrane in accordance with GUTEX system partner
- **GUTEX Thermoflex®** between the rafters
- Existing mineral wool with aluminium lining
- Profiled wood formwork min. 10 mm

U-factor in (W/m²K)¹⁾, phase shift in hours (h)

Existing MW WLZ 040 (mm)	GUTEX Thermoflex® (mm)	GUTEX Ultratherm® (mm)				
		GUTEX Multiplex-top® (mm)	35	50	60	80
80	40	0.28	0.25	0.23	0.21	
		7.9	9.0	9.8	11.3	
	60	0.25	0.22	0.21	0.19	
		8.5	9.7	10.4	12.0	
	80	0.22	0.20	0.19	0.18	
		9.2	10.4	11.2	12.7	
	100	0.20	0.19	0.18	0.16	
		9.9	11.1	11.9	13.4	
	120	0.19	0.17	0.17	0.15	
		10.7	11.8	12.6	14.1	
	100	40	0.25	0.22	0.21	0.19
			8.1	9.2	10.0	11.6
60		0.22	0.20	0.20	0.18	
		8.8	9.9	10.7	12.3	
80		0.20	0.19	0.18	0.17	
		9.5	10.7	11.5	13.0	
100		0.19	0.17	0.17	0.15	
		10.3	11.4	12.2	13.7	
120		40	0.22	0.21	0.20	0.18
			8.4	9.5	10.3	11.8
	60	0.20	0.19	0.18	0.17	
		9.1	10.2	11.0	12.5	
	80	0.19	0.17	0.17	0.15	
		9.8	10.9	11.7	13.2	

U-factor in (W/m²K)¹⁾, phase shift in hours (h)

Existing MW WLZ 040 (mm)	GUTEX Thermoflex® (mm)	GUTEX Ultratherm® (mm)				
		100	120	140	160	
80	40	0.19	0.17	0.16	0.15	
		12.7	14.1	15.5	16.8	
	60	0.18	0.16	0.15	0.14	
		13.4	14.8	16.1	17.5	
	80	0.16	0.15	0.14	0.13	
		14.1	15.5	16.8	18.2	
	100	0.15	0.14	0.13	0.12	
		14.8	16.2	17.5	18.9	
	120	0.14	0.13	0.13	0.12	
		15.5	16.9	18.3	19.6	
	100	40	0.18	0.16	0.15	0.14
			13.0	14.4	15.8	17.1
60		0.16	0.15	0.14	0.13	
		13.7	15.1	16.4	17.8	
80		0.15	0.14	0.13	0.13	
		14.4	15.8	17.1	18.5	
100		0.14	0.13	0.13	0.12	
		15.1	16.5	17.9	19.2	
120		40	0.16	0.15	0.14	0.13
			13.3	14.7	16.0	17.4
	60	0.15	0.14	0.13	0.13	
		14.0	15.3	16.7	18.1	
	80	0.14	0.13	0.13	0.12	
		14.7	16.0	17.4	18.8	

1) Calculation with 10 % wood content

I. Flat roof

I.5 New build/reconstruction

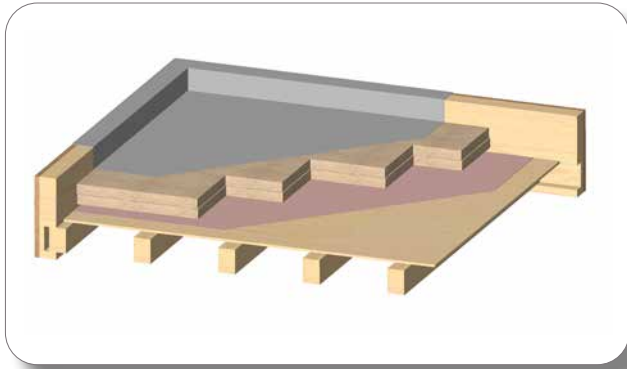

I.5.1 Open beam position

Structure:

- Membrane seal
- **GUTEX Thermoflat®**
- Air seal/vapour barrier, moisture variable
- Exposed formwork 30 mm
- Exposed beam position

GUTEX Thermoflat® (mm)	U-factor (W/m²K)	Phase shift (h)
200*	0.18	15.6
220*	0.17	16.9
240*	0.15	18.1
260*	0.14	19.4
280*	0.13	20.7

* double-layer installation

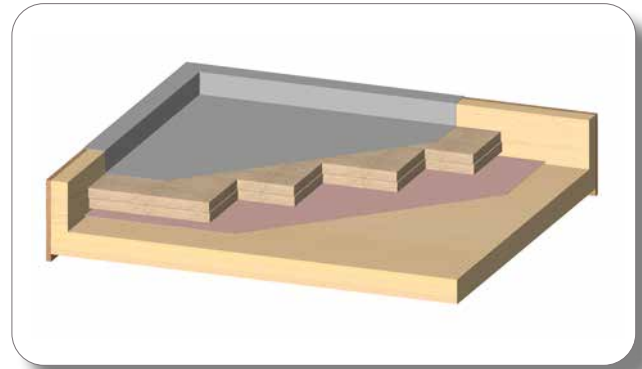

I.5.2 Solid wood ceiling

Structure:

- Membrane seal
- **GUTEX Thermoflat®**
- Air seal/vapour barrier, moisture variable
- Solid wood ceiling element 130 mm

GUTEX Thermoflat® (mm)	U-factor (W/m²K)	Phase shift (h)
200*	0.19	19.0
200*	0.16	21.6
220*	0.15	22.9
240*	0.14	24.1
260*	0.13	25.4
280*	0.12	26.6

**Note: Customised tapered insulation can be requested and supplied.
A building physics proof is required for these constructions.**

I. Flat roof

I.5 New build/reconstruction

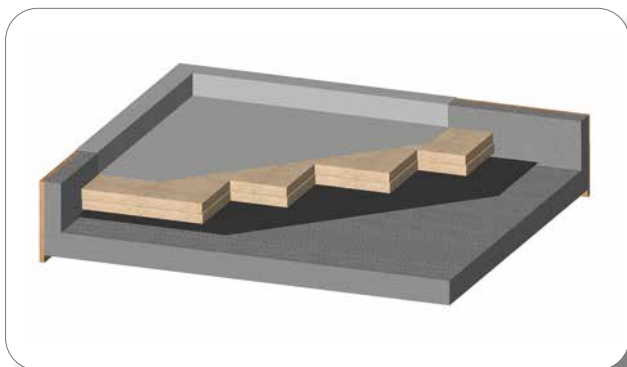

I.5.3 Concrete

Structure:

- Membrane seal
- **GUTEX Thermoflat®**
- Sealing membrane
- Concrete 140 mm

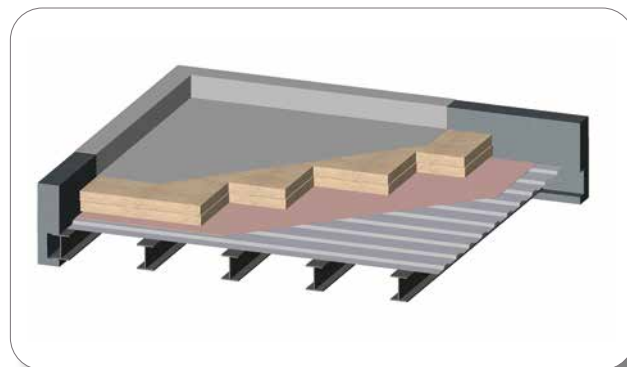

I.5.4 Steel plate

Structure:

- Membrane seal
- **GUTEX Thermoflat®**
- Sealing membrane
- Steel plate

GUTEX Thermoflat® (mm)	U-factor (W/m²K)	Phase shift (h)
200*	0.19	16.7
220*	0.17	18.0
240*	0.16	19.2
260*	0.14	20.5
280*	0.13	21.8

GUTEX Thermoflat® (mm)	U-factor (W/m²K)	Phase shift (h)
200*	0.19	12.8
220*	0.17	14.1
240*	0.16	15.3
260*	0.15	16.6
280*	0.14	17.9

* double-layer installation

Note: Customised tapered insulation can be requested and supplied. A building physics proof is required for these constructions.

2. Exterior wall

2.1 Timber frame construction



2.1.1 Rear-ventilated facade

Structure:

- Plaster building board 12.5 mm
- Air seal/panelling 15 mm
- **GUTEX Thermofibre®/GUTEX Thermoflex®** between timber uprights
- **GUTEX Multitherm®**
- Counter battens
- Wood formwork



2.1.2 Rear-ventilated facade with installation level

Structure:

- Plaster building board 12.5 mm
- **GUTEX Thermoinstal®** 50 mm
- Air seal/panelling 15 mm
- **GUTEX Thermofibre®/GUTEX Thermoflex®** between timber uprights
- **GUTEX Multitherm®**
- Counter battens
- Battens
- Wood formwork vertical

GUTEX Multitherm® (mm)	GUTEX Thermofibre®/Thermoflex® (mm)	U-factor ¹⁾ (W/m²K)	Phase shift (h)	Noise ²⁾ insulation value R _{W,R} (dB)
20	160	0.23	9.5	> 45
	180	0.21	10.2	
	200	0.19	11.0	
	220	0.18	11.7	
	240	0.17	12.4	
40	160	0.21	10.8	
	180	0.19	11.5	
	200	0.17	12.3	
	220	0.16	13.0	
	240	0.15	13.7	
60	160	0.18	12.2	
	180	0.17	12.9	
	200	0.16	13.7	
	220	0.15	14.4	
	240	0.14	15.1	
80	160	0.17	13.6	
	180	0.16	14.3	
	200	0.15	15.0	
	220	0.14	15.8	
	240	0.13	16.5	
100	160	0.15	14.9	
	180	0.14	15.6	
	200	0.14	16.3	
	220	0.13	17.1	
	240	0.12	17.8	
120	160	0.14	16.2	
	180	0.13	16.9	
	200	0.13	17.6	
	220	0.12	18.3	
	240	0.11	19.1	
140	160	0.13	17.4	
	180	0.13	18.2	
	200	0.12	18.9	
	220	0.11	19.6	
	240	0.11	20.3	
160	160	0.12	18.7	
	180	0.12	19.4	
	200	0.11	20.1	
	220	0.11	20.9	
	240	0.10	21.6	

GUTEX Multitherm (mm)	GUTEX Thermofibre®/Thermoflex® (mm)	U-factor ¹⁾ (W/m²K)	Phase shift (h)	Noise ²⁾ insulation value R _{W,R} (dB)
20	160	0.18	13.0	> 45
	180	0.16	13.7	
	200	0.15	14.4	
	220	0.14	15.2	
	240	0.14	15.9	
40	160	0.16	14.3	
	180	0.15	15.0	
	200	0.14	15.8	
	220	0.13	16.5	
	240	0.13	17.2	
60	160	0.15	15.7	
	180	0.14	16.4	
	200	0.13	17.2	
	220	0.12	17.9	
	240	0.12	18.6	
80	160	0.14	17.1	
	180	0.13	17.8	
	200	0.12	18.5	
	220	0.12	19.3	
	240	0.11	20.0	
100	160	0.13	18.4	
	180	0.12	19.1	
	200	0.12	19.8	
	220	0.11	20.6	
	240	0.11	21.3	
120	160	0.12	19.7	
	180	0.11	20.4	
	200	0.11	21.1	
	220	0.10	21.8	
	240	0.10	22.6	
140	160	0.11	20.9	
	180	0.11	21.7	
	200	0.10	22.4	
	220	0.10	23.1	
	240	0.09	23.8	
160	160	0.11	22.2	
	180	0.10	22.9	
	200	0.10	23.6	
	220	0.09	24.4	
	240	0.09	25.1	

1) Calculation with 10 % wood content

2) Values in accordance with "Informationsdienst Holz", series 3, part 3, sequence 4, R_{W,R} = calculated value incl. allowance

2. Exterior wall

2.1 Timber frame construction



2.1.3 Plaster facade

Structure:

- Plaster building board 12.5 mm
- OSB board (air seal) 15 mm
- **GUTEX Thermofibre®/GUTEX Thermoflex®** between timber uprights
- **GUTEX Thermowall (-gf/F90)**
- **GUTEX plaster system**



2.1.4 Plaster facade with Installation level

Structure:

- Plaster building board 12.5 mm
- **GUTEX Thermo-instal®** 50 mm
- OSB board (air seal) 15 mm
- **GUTEX Thermofibre®/GUTEX Thermoflex®** between timber uprights
- **GUTEX Thermowall (-gf/F90)**
- **GUTEX plaster system**

Wall

	Thick-ness (mm)	GUTEX Thermofibre®/Thermoflex® (mm)	U-factor ¹⁾ (W/m ² K)	Phase shift (h)	Noise insulation value R _{w,R} (dB) ²⁾	
GUTEX Thermowall-gf /F90	40	140	0.23	10.4	40	
		160	0.21	11.1		
		180	0.19	11.8		
		200	0.18	12.6		
		220	0.16	13.3		
		240	0.15	14.0		
	60	140	0.21	12.0		
		160	0.19	12.7		
		180	0.18	13.4		
		200	0.16	14.2		
		220	0.15	14.9		
		240	0.14	15.6		
		80	140	0.18		13.3
			160	0.17		14.0
180	0.16		14.7			
200	0.15		15.5			
220	0.14		16.2			
240	0.13		16.9			
GUTEX Thermowall®	100	140	0.17	14.7	44	
		160	0.15	15.4		
		180	0.14	16.1		
		200	0.14	16.9		
		220	0.13	17.6		
		240	0.12	18.3		
	120	140	0.15	16.1		
		160	0.14	16.8		
		180	0.13	17.5		
		200	0.13	18.2		
		220	0.12	18.8		
		240	0.11	19.7		
		140	140	0.14		17.4
			160	0.13		18.1
180	0.13		18.8			
200	0.12		19.5			
220	0.11		20.3			
240	0.11		21.0			
160	140	0.13	18.8			
	160	0.12	19.5			
	180	0.12	20.2			
	200	0.11	20.9			
	220	0.11	21.6			
	240	0.10	22.3			

	Thick-ness (mm)	GUTEX Thermofibre®/Thermoflex® (mm)	U-factor ¹⁾ (W/m ² K)	Phase shift (h)	Noise insulation value R _{w,R} (dB) ²⁾			
GUTEX Thermowall-gf /F90	40	140	0.18	13.9	42			
		160	0.16	14.6				
		180	0.15	15.3				
		200	0.14	16.0				
		220	0.13	16.8				
		240	0.13	17.5				
	60	140	0.16	15.5				
		160	0.15	16.2				
		180	0.14	16.9				
		200	0.13	17.7				
		220	0.13	18.4				
		240	0.12	19.1				
		GUTEX Thermowall®	80	140		0.15	16.8	47
				160		0.14	17.5	
180	0.13			18.2				
200	0.12			19.0				
220	0.12			19.7				
240	0.11			20.4				
100	140		0.14	18.2				
	160		0.13	18.9				
	180		0.12	19.6				
	200		0.12	20.3				
	220		0.11	21.1				
	240		0.10	21.8				
	120		140	0.13	19.6			
			160	0.12	20.3			
180		0.11	21.0					
200		0.11	21.7					
220		0.10	22.4					
240		0.10	23.1					
140		140	0.12	20.9				
		160	0.11	21.6				
		180	0.11	22.3				
		200	0.10	23.0				
		220	0.10	23.8				
		240	0.09	24.5				
160	140	0.11	22.2					
	160	0.11	23.0					
	180	0.10	23.7					
	200	0.10	24.4					
	220	0.09	25.1					
	240	0.09	25.8					

1) Calculation with 10 % wood content

2) Executed in accordance with inspection certificate P-SAC-02/III-321

2. Exterior wall

2.2 Brickwork reconstruction, from outside.



2.2.1 Rear-ventilated facade

Structure:

- Existing plaster coating
- Existing brickwork 24 cm ¹⁾
- Existing plaster coating
- **GUTEX Multitherm**[®]
- Water-carrying, UV-resistant, permeable membrane
- Counter battens
- Joint formwork

GUTEX Multitherm [®] (mm)	U-factor (W/m ² K)	Phase shift (h)
40	0.64	12.5
60	0.48	13.3
80	0.39	14.3
100	0.32	15.4
120	0.28	16.7
140	0.24	17.9
160	0.22	19.2

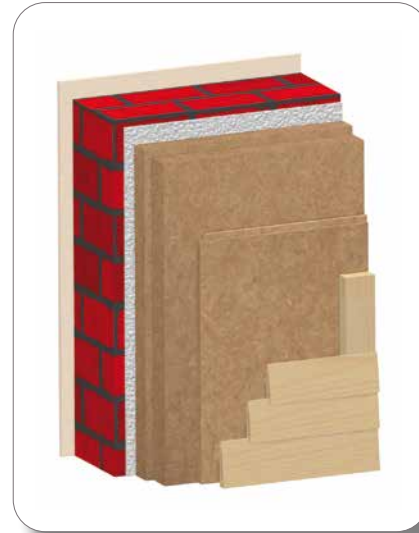

2.2.2 Rear-ventilated facade

Structure:

- Existing plaster coating
- Existing brickwork 24 cm ¹⁾
- Existing plaster coating
- **GUTEX Thermosafe-homogen**[®]
- **GUTEX Multitherm**[®]
- Counter battens
- Wood formwork, closed

GUTEX Thermosafe-homogen [®] (mm)	GUTEX Multitherm [®] (mm)	U-factor (W/m ² K)	Phase shift (h)
100	20	0.27	16.1
120	20	0.23	17.3
140	20	0.21	18.4
160	20	0.19	19.6
180	20	0.17	20.7
200	20	0.15	21.9
220	20	0.14	23.1
240	20	0.13	24.2
240	40	0.12	25.5
240	60	0.12	26.8

1) Assumed λ value = 0.70 W/mK

2. Exterior wall

2.2 Brickwork reconstruction, from outside.



2.2.3 Rear-ventilated facade with substructure

Structure:

- Existing plaster coating
- Existing brickwork 24 cm ¹⁾
- Existing plaster coating
- **GUTEX Thermofibre®/GUTEX Thermoflex®** between timber frames
- **GUTEX Multitherm®**
- Counter battens
- Wood formwork, closed

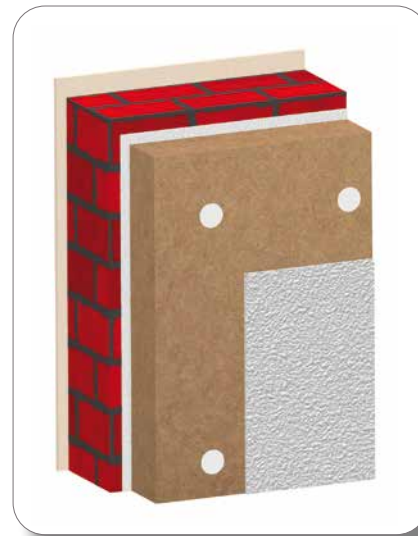

2.2.4 Plaster facade

Structure:

- Existing plaster coating
- Existing brickwork 24 cm ¹⁾
- Existing plaster coating
- **GUTEX Thermowall®**
- **GUTEX plaster system**

GUTEX Multitherm® (mm)	GUTEX Thermofibre®/ Thermoflex® (mm)	U-factor (W/m²K) ²⁾	Phase shift (h)
20	140	0.24	15.2
	160	0.22	15.9
	180	0.20	16.6
40	140	0.21	16.5
	160	0.20	17.2
	180	0.18	17.9
60	140	0.19	17.9
	160	0.18	18.6
	180	0.17	19.3
80	140	0.18	19.3
	160	0.16	20.0
	180	0.15	20.7
100	140	0.16	20.6
	160	0.15	21.3
	180	0.14	22.0
120	140	0.15	21.8
	160	0.14	22.5
	180	0.13	23.3
140	140	0.14	23.1
	160	0.13	23.8
	180	0.12	24.5
160	140	0.13	24.4
	160	0.12	25.1
	180	0.12	25.8

GUTEX Thermowall® (mm)	U-factor (W/m²K)	Phase shift (h)
60	0.48	13.5
80	0.38	14.6
100	0.32	15.9
120	0.28	17.3
140	0.24	18.6
160	0.21	20.0

1) Assumed λ value = 0.70 W/mK

2) Calculation with 10% wood content

2. Exterior wall

2.2 Brickwork reconstruction, from outside.

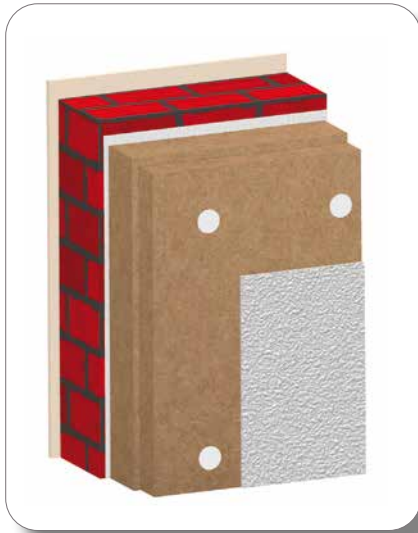

2.2.5 Plaster facade, two-layer

Structure:

- Existing plaster coating
- Existing brickwork 24 cm ¹⁾
- Existing plaster coating
- **GUTEX Thermosafe-homogen[®]**
- **GUTEX Thermowall[®]**
- **GUTEX plaster system[®]**



2.2.6 Plaster facade with substructure

Structure:

- Existing plaster coating
- Existing brickwork 24 cm ¹⁾
- Existing plaster coating
- **GUTEX Thermofibre[®]/GUTEX Thermoflex[®]**
between timber frames
- **GUTEX Thermowall[®](-gf/F90)**
- **GUTEX plaster system[®]**

GUTEX Thermowall [®] (mm)	GUTEX Thermosafe-homogen [®] (mm)	U-factor (W/m ² K)	Phase shift (h)
60	120	0.19	20.1
	140	0.17	21.2
	160	0.16	22.4
80	160	0.14	23.8
	180	0.13	24.9
	200	0.12	26.1
100	200	0.12	27.5

GUTEX Thermowall [®] (mm)	GUTEX Thermofibre [®] / Thermoflex [®] (mm)	U-factor (W/m ² K) ²⁾	Phase shift (h)
40	140	0.22	16.8
	160	0.20	17.5
	180	0.18	18.2
60	140	0.20	18.4
	160	0.18	19.1
	180	0.17	19.8
80	140	0.17	19.7
	160	0.16	20.4
	180	0.15	21.1
100	140	0.16	21.1
	160	0.15	21.8
	180	0.14	22.5
120	140	0.15	22.4
	160	0.14	23.1
	180	0.13	23.8

1) Assumed λ value = 0.70 W/mK

2) Calculation with 10% wood content

2. Exterior wall

2.3 Brickwork reconstruction, from inside.



2.3.1 Brickwork with interior panelling

Structure:

- Existing plaster coating
- Existing brickwork¹⁾
- Existing plaster coating
- **GUTEX Thermosafe-wd[®]**
- Vapour barrier/air seal
- Battens
- Plaster building board/wood formwork

GUTEX Thermosafe-wd [®] (mm)	U-factor (W/m ² K)	Phase shift (h)
40	0.62	12.7
60	0.47	14.2
80	0.38	15.5
100	0.32	16.7
120	0.27	17.9
140	0.24	19.2
160	0.21	20.5



2.3.2 Brickwork, plastered inside

Structure:

- Existing plaster coating
- Existing brickwork¹⁾
- Existing plaster coating
- **GUTEX Thermoroom[®]**
- Plaster coating

GUTEX Thermoroom [®] (mm)	U-factor (W/m ² K)	Phase shift (h)
40	0.62	13.5
60	0.47	14.8
80	0.38	16.0
100	0.31	17.1

1) Assumed λ value = 0.70 W/mK

2. Exterior wall

2.4 Stud wall reconstruction, from outside.



2.4.1 Plaster facade

Structure:

- Existing plaster coating
- Existing half timber¹⁾
- Existing plaster coating
- **GUTEX Thermowall®**
- **GUTEX plaster system**

GUTEX Thermowall® (mm)	U-factor (W/m²K)	Phase shift (h)
100	0.33	12.4
120	0.28	13.7
140	0.25	15.1
160	0.22	16.4



2.4.2 Rear-ventilated facade

Structure:

- Existing plaster coating
- Existing half timber¹⁾
- Existing plaster coating
- **GUTEX Thermosafe-homogen®**
- **GUTEX Multitherm®**
- Counter battens
- Wood formwork

GUTEX Thermosafe-homogen® (mm)	GUTEX Multitherm® (mm)	U-factor (W/m²K)	Phase shift (h)
100	20	0.27	12.5
120	20	0.24	13.6
140	20	0.21	14.8
160	20	0.19	16.0
180	20	0.17	17.1
200	20	0.16	18.3
220	20	0.14	19.4
240	20	0.13	20.6
240	40	0.13	21.8
240	60	0.12	23.1

1) Assumed λ value = 0.81 W/mK

2. Exterior wall

2.4 Stud wall reconstruction, from inside



2.4.3 Half timber, plastered inside

Structure:

- Existing half timber 11 cm ¹⁾
- Lime and cement plaster
- **GUTEX Thermoroom®**
- Plaster coating

GUTEX Thermoroom® (mm)	U-factor (W/m ² K)	Phase shift (h)
40	0.67	9.2
60	0.5	10.6
80	0.39	11.9
100	0.33	13.1



2.4.4 Half timber with interior panelling

Structure:

- Existing half timber 11 cm ¹⁾
- Lime and cement plaster
- **GUTEX Thermosafe-wd®**
- Vapour barrier/air seal
- Battens
- PB/PF/wood formwork

GUTEX Thermosafe-wd® (mm)	U-factor (W/m ² K)	Phase shift (h)
40	0.66	9.3
60	0.49	10.8
80	0.39	12.1
100	0.33	13.3
120	0.28	14.6
140	0.24	15.8
160	0.22	17.1

1) Assumed λ value = 0.81 W/mK

2. Exterior wall

2.5 Brickwork new build, insulation, from outside

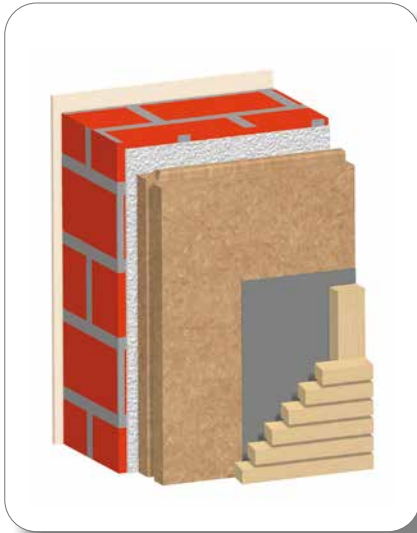

2.5.1 Rear-ventilated facade

Structure:

- Plaster coating
- Brick, highly-insulating, 36 cm¹⁾
- **GUTEX Multitherm**[®]
- Water-carrying, UV-resistant, permeable membrane
- Counter battens
- Joint formwork[®]

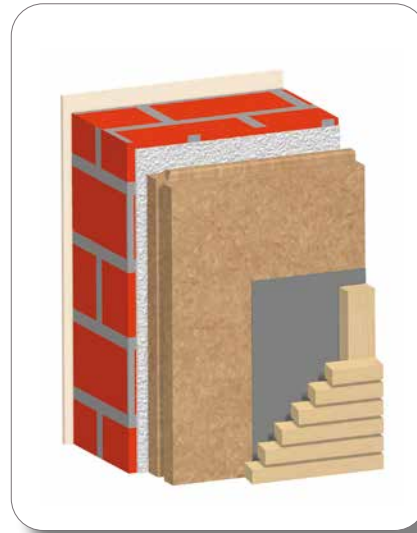

2.5.2 Rear-ventilated facade

Structure:

- Plaster coating
- Brick, highly-insulating, 36 cm²⁾
- **GUTEX Multitherm**[®]
- Water-carrying, UV-resistant, permeable membrane
- Counter battens
- Joint formwork

GUTEX Multitherm (mm)	U-factor (W/m ² K)	Phase shift (h)
60	0.17	27.7
80	0.16	28.8
100	0.15	29.9
120	0.14	31.2
140	0.13	32.4
160	0.12	33.7

GUTEX Multitherm [®] (mm)	U-factor (W/m ² K)	Phase shift (h)
60	0.24	22.7
80	0.21	23.7
100	0.19	24.9
120	0.18	26.1
140	0.16	27.4
160	0.15	28.7

1) Assumed λ value = 0.09 W/mK

2) Assumed λ value = 0.15 W/mK

2. Exterior wall

2.5 Brickwork new build, insulation, from outside

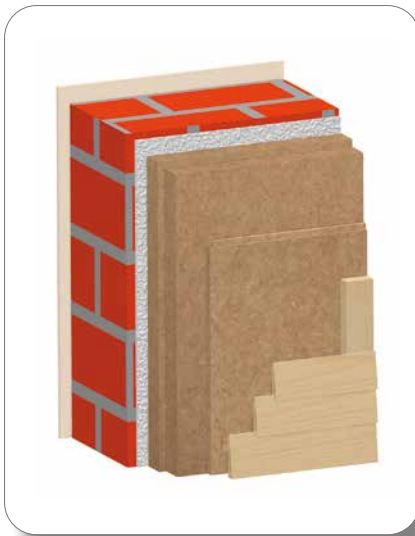

2.5.3 Rear-ventilated facade

Structure:

- Plaster coating
- Brick, highly-insulating, 36 cm¹⁾
- **GUTEX Thermosafe-homogen**[®] 240 mm
- **GUTEX Multitherm**[®]
- Counter battens
- Wood formwork, closed

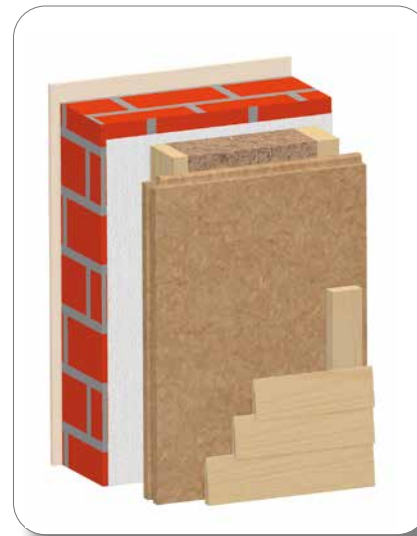

2.5.4 Rear-ventilated facade with substructure

Structure:

- Plaster coating
- Brick, highly-insulating, 36 cm¹⁾
- **GUTEX Thermofibre**[®]/**GUTEX Thermoflex**[®] between timber frames
- **GUTEX Multitherm**[®]
- Counter battens
- Wood formwork, closed

GUTEX Thermosafe-homogen [®] (mm)	GUTEX Multitherm [®] (mm)	U-factor (W/m ² K)	Phase shift (h)
100	20	0.13	30.5
120	20	0.13	31.7
140	20	0.12	32.8
160	20	0.11	34
180	20	0.10	35.2
200	20	0.10	36.3
220	20	0.09	37.5
240	20	0.09	38.6
240	40	0.09	39.9
240	60	0.08	41.2

GUTEX Multitherm [®] (mm)	GUTEX Thermofibre [®] / Thermoflex [®] (mm)	U-factor (W/m ² K) ²⁾	Phase shift (h)
20	140	0.13	29.8
	160	0.12	30.5
	180	0.11	31.2
40	140	0.12	31.0
	160	0.11	31.8
	180	0.11	32.5
60	140	0.11	32.5
	160	0.11	33.2
	180	0.10	33.9
80	140	0.11	33.8
	160	0.10	34.5
	180	0.10	35.3
100	140	0.10	35.1
	160	0.10	35.9
	180	0.09	36.6
120	140	0.10	36.4
	160	0.09	37.1
	180	0.09	37.8
140	140	0.09	37.7
	160	0.09	38.4
	180	0.08	39.1
160	140	0.09	38.9
	160	0.08	39.6
	180	0.08	40.4

1) Assumed λ value = 0.09 W/mK
 2) Calculation with 10% wood content

2. Exterior wall

2.5 Brickwork new build, insulation, from outside

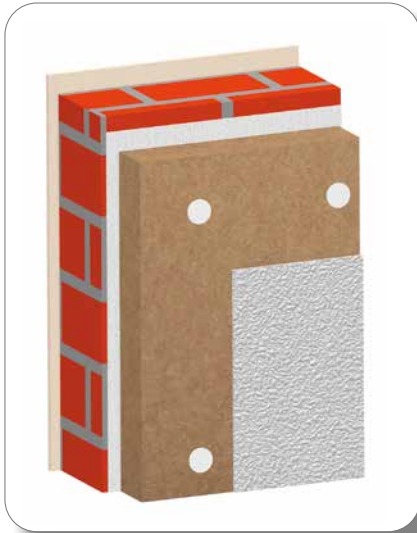

2.5.5 Plaster facade, single-layer

Structure:

- Plaster coating
- Brick, highly-insulating, 36 cm¹⁾
- GUTEX Thermowall®
- GUTEX plaster system



2.5.6 Plaster facade, single-layer

Structure:

- Plaster coating
- Brick, 36 cm²⁾
- GUTEX Thermowall®
- GUTEX plaster system

GUTEX Thermowall® (mm)	U-factor (W/m ² K)	Phase shift (h)
60	0.17	27.9
80	0.15	29.1
100	0.15	30.4
120	0.14	31.7
140	0.13	33.1
160	0.12	34.4

GUTEX Thermowall® (mm)	U-factor (W/m ² K)	Phase shift (h)
60	0.24	22.9
80	0.21	24.1
100	0.19	25.4
120	0.18	26.7
140	0.16	28.1
160	0.15	29.4

1) Assumed λ value = 0.09 W/mK

2) Assumed λ value = 0.15 W/mK

2. Exterior wall

2.5 Brickwork new build, insulation, from outside

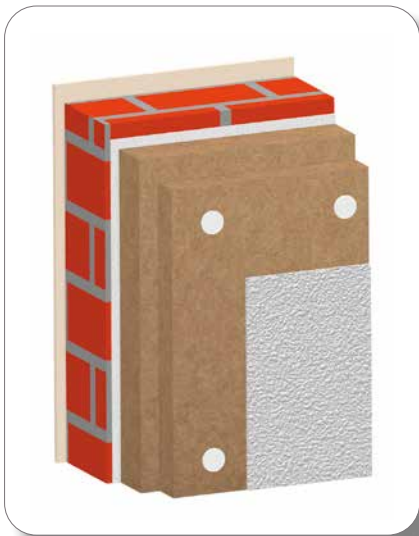

2.5.7 Plaster facade, double-layer

Structure:

- Plaster coating
- Brick, highly-insulating, 36 cm²)
- GUTEX Thermosafe-homogen®
- GUTEX Thermowall®
- GUTEX plaster system

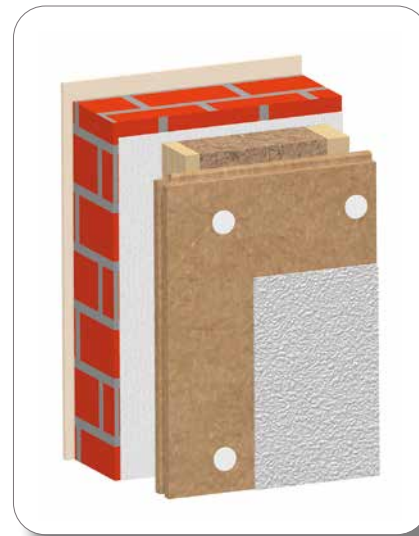

2.5.8 Plaster facade with substructure

Structure:

- Plaster coating
- Brick, highly-insulating, 36 cm²)
- GUTEX Thermofibre®/GUTEX Thermoflex® between timber frames
- GUTEX Thermowall/-gf / F90
- GUTEX plaster system

GUTEX Thermowall® (mm)	GUTEX Thermosafe-homogen® (mm)	U-factor (W/m²K)	Phase shift (h)
60	120	0.11	34.6
	140	0.10	35.8
	160	0.10	36.9
80	100	0.11	34.8
	120	0.11	36.0
	140	0.10	37.1

GUTEX Thermowall/-gf / F90® (mm)	GUTEX Thermofibre®/GUTEX Thermoflex® (mm)	U-factor (W/m²K) 1)	Phase shift (h)
40	140	0.12	31.4
	160	0.11	32.1
	180	0.11	32.8
60	140	0.11	33.0
	160	0.11	33.7
	180	0.10	34.4
80	140	0.11	34.3
	160	0.10	35.0
	180	0.10	35.7
100	140	0.10	35.7
	160	0.10	36.4
	180	0.09	37.1
120	140	0.10	37.0
	160	0.10	37.7
	180	0.09	38.4
140	120	0.10	37.7
	140	0.09	38.4
	160	0.09	39.1
160	120	0.09	39.0
	140	0.09	39.7
	160	0.08	40.4

1) Calculation with 10 % wood content
 2) Assumed λ value = 0.09 W/mK

2. Exterior wall

2.6 Prefabricated house reconstruction



2.6.1 Plaster facade

Structure:

- Existing plasterboard 12.5 mm
- Existing chipboard 19 mm
- Existing PE membrane
- **GUTEX Thermofibre®/GUTEX Thermoflex®** between timber uprights
- **GUTEX Thermowall (-gff/F90)**
- **GUTEX plaster system**



2.6.2 Rear-ventilated facade

Structure:

- Existing plasterboard 12.5 mm
- Existing chipboard 19 mm
- Existing PE membrane
- **GUTEX Thermofibre®/GUTEX Thermoflex®** between timber uprights
- **GUTEX Multitherm®**
- Counter battens
- Facade

GUTEX Thermofibre®/ Thermoflex® between timber uprights (mm)	GUTEX Thermowall (-gff/F90) (mm)	U-factor (W/m²K) ¹⁾	Phase shift (h)
140	40	0.23	10.6
	60	0.21	12.2
	80	0.18	13.6
	100	0.16	14.9
	120	0.15	16.3
	140	0.14	17.6
	160	0.13	19.0
160	40	0.21	11.3
	60	0.19	13.0
	80	0.17	14.3
	100	0.15	15.6
	120	0.14	17.0
	140	0.13	18.3
	160	0.12	19.7

GUTEX Thermofibre®/ Thermoflex® between timber uprights (mm)	GUTEX Multitherm® (mm)	U-factor (W/m²K) ¹⁾	Phase shift (h)
140	40	0.22	10.3
	60	0.20	11.7
	80	0.18	13.1
	100	0.17	14.4
	120	0.15	15.7
	140	0.14	17.0
	160	0.13	18.2
160	40	0.20	11.0
	60	0.18	12.5
	80	0.17	13.8
	100	0.15	15.1
	120	0.14	16.4
	140	0.13	17.7
	160	0.12	18.9

1) Calculation with 10 % wood content

2. Exterior wall

2.6 Prefabricated house reconstruction

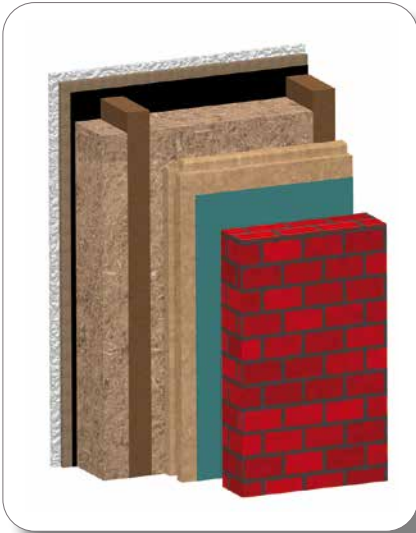

2.6.3 Rear-ventilated wall facing

Structure:

- Existing plasterboard 12.5 mm
- Existing chipboard 19 mm
- Existing PE membrane
- **GUTEX Thermofibre®/ GUTEX Thermoflex®** between timber uprights
- **GUTEX Multitherm**
- Wall formwork sheeting pro clima SOLITEX FRONTA HUMIDA
- Rear-ventilated clinker brick facade

GUTEX Thermofibre®/ Thermoflex® between timber uprights (mm)	GUTEX Multitherm® (mm)	U-factor (W/m²K) ¹⁾	Phase shift (h)
140	40	0.22	10.3
	60	0.20	11.7
	80	0.18	13.1
	100	0.17	14.4
	120	0.15	15.7
	140	0.14	17.0
	160	0.13	18.2
160	40	0.20	11.0
	60	0.18	12.5
	80	0.17	13.8
	100	0.15	15.1
	120	0.14	16.4
	140	0.13	17.7
	160	0.12	18.9

1) Calculation with 10% wood content

2. Exterior wall

2.7 Solid wood element



2.7.1 Rear-ventilated facade with installation level

Structure:

- Plaster building board 12.5 mm
- **GUTEX Thermoinstal®** 50 mm
- Vapour barrier/air seal
- Solid wood wall element 100 mm
- **GUTEX Multitherm®**
- Water-carrying, UV-resistant, permeable membrane
- Counter battens
- Joint formwork

GUTEX Multitherm® (mm)	U-factor (W/m²K)	Phase shift (h)	Noise insulation value $R_{w,R}$ (dB) ¹⁾
100	0.21	18.5	< 50
120	0.19	19.8	
140	0.17	21.0	
160	0.16	22.3	



2.7.2 Rear-ventilated facade

Structure:

- Plaster building board 12.5 mm
- Vapour barrier/air seal
- Solid wood wall element 100 mm
- **GUTEX Thermosafe-homogen®**
- **GUTEX Multitherm®** 20 mm
- Counter battens
- Wood formwork

GUTEX Thermosafe-homogen® (mm)	U-factor (W/m²K)	Phase shift (h)	Noise insulation value $R_{w,R}$ (dB) ¹⁾
100	0.24	15.0	< 45
120	0.21	16.2	
140	0.19	17.3	
160	0.17	18.5	
180	0.16	19.7	
200	0.14	20.8	
220	0.13	22.0	
240	0.13	23.1	

¹⁾ Values in accordance with "Informationsdienst Holz", series 3, part 3, sequence 4, $R_{w,R}$ = calculated value incl. allowance

2. Exterior wall

2.7 Solid wood element



2.7.3 Rear-ventilated facade with installation level

Structure:

- Plaster building board
- **GUTEX Thermostal®** 50 mm
- Vapour barrier/air seal
- Solid wood wall element 100 mm
- **GUTEX Thermosafe-homogen®**
- **GUTEX Multitherm®** 20 mm
- Counter battens
- Wood formwork



2.7.4 Rear-ventilated facade with substructure

Structure:

- Solid wood wall element 100 mm
- **GUTEX Thermofibre®/GUTEX Thermoflex®** between double I-joists
- **GUTEX Multitherm®**
- Water-carrying, UV-resistant, permeable membrane
- Counter battens
- Joint formwork

GUTEX Thermosafe-homogen® (mm)	U-factor (W/m²K)	Phase shift (h)	Noise insulation value $R_{w,R}$ (dB) ²⁾
100	0.18	19.1	< 47
120	0.17	20.2	
140	0.15	21.4	
160	0.14	22.6	
180	0.13	23.7	
200	0.12	24.9	
220	0.11	26.0	
240	0.11	27.2	

GUTEX Multitherm® (mm)	GUTEX Thermofibre®/Thermoflex® (mm)	U-factor (W/m²K) ¹⁾	Phase shift (h)
20	200	0.16	16.3
	220	0.15	17.1
	240	0.15	17.8
	300	0.13	20.0
	360	0.11	22.2
	400	0.11	23.6
40	200	0.15	17.6
	220	0.14	18.4
	240	0.14	19.1
	300	0.12	21.3
	360	0.11	23.5
60	200	0.14	19.0
	220	0.13	19.8
	240	0.13	20.5
	300	0.11	22.7
	360	0.10	24.9
	400	0.10	26.3

1) Calculation with 10 % wood content

2) Values in accordance with "Informationsdienst Holz", series 3, part 3, sequence 4, $R_{w,R}$ = calculated value incl. allowance

2. Exterior wall

2.7 Solid wood element



2.7.5 Plaster facade, single-layer

Structure:

- Plaster building board 12.5 mm
- Vapour barrier/air seal
- Solid wood wall element 100 mm
- **GUTEX Thermowall®**
- **GUTEX plaster system®**



2.7.6 Plaster facade, single-layer, with installation level

Structure:

- Plaster building board 12.5 mm
- **GUTEX Thermoinstal®** 50 mm
- Vapour barrier/air seal
- Solid wood wall element 100 mm
- **GUTEX Thermowall®**
- **GUTEX plaster system®**

GUTEX Thermowall (mm)	U-factor (W/m ² K)	Phase shift (h)	Noise insulation value R _{w,R} (dB) ¹⁾
100	0.28	14.9	38
120	0.25	16.3	
140	0.22	17.7	
160	0.20	19.0	

GUTEX Thermoinstal® (mm)	U-factor (W/m ² K)	Phase shift (h)	Noise insulation value R _{w,R} (dB) ¹⁾
100	0.21	19.0	40
120	0.19	20.4	
140	0.17	21.7	
160	0.16	23.1	

1) Execution in accordance with inspection certificate P-SAC-02/III-321

2. Exterior wall

2.7 Solid wood element



2.7.7 Plaster facade, double-layer with installation level

Structure:

- Plaster building board 12.5 mm
- **GUTEX Thermoinstal®** 50 mm
- Vapour barrier/air seal
- Solid wood wall element 100 mm
- **GUTEX Thermosafe-homogen®**
- **GUTEX Thermowall®**
- **GUTEX plaster system**



2.7.8 Plaster facade with substructure

Structure:

- Plaster building board 12.5 mm
- **GUTEX Thermoinstal®** 50 mm
- Vapour barrier/air seal
- Solid wood wall element 100 mm
- **GUTEX Thermofibre®/GUTEX Thermoflex®** between double I-joists
- **GUTEX Thermowall (-gf/F90)**
- **GUTEX plaster system**

GUTEX Thermowall® (mm)	GUTEX Thermosafe-homogen® (mm)	U-factor (W/m²K)	Phase shift (h)	Noise insulation value R _{w,R} (dB) ²⁾
60	120	0.14	23.2	40
	140	0.13	24.3	
	160	0.12	25.5	
	180	0.12	26.6	
	200	0.11	27.8	
	220	0.10	28.9	
	240	0.10	30.1	
80	120	0.13	24.6	
	140	0.12	25.7	
	160	0.12	26.9	
	180	0.11	28.0	
	200	0.10	29.2	
	220	0.10	30.3	
100	120	0.12	25.9	
	140	0.12	27.1	
	160	0.11	28.2	
	180	0.10	29.4	
	200	0.10	30.5	

GUTEX Thermowall (-gf/F90) (mm)	GUTEX Thermofibre®/Thermoflex® (mm)	U-factor (W/m²K) ¹⁾	Phase shift (h)
40	200	0.13	22.0
	220	0.12	22.7
	240	0.12	23.5
	300	0.10	25.7
	360	0.09	27.8
	400	0.09	29.3
	60	200	0.12
220		0.11	24.3
240		0.11	25.1
300		0.10	27.2
360		0.09	29.4
400		0.09	30.9
80	200	0.11	24.9
	220	0.11	25.6
	240	0.10	26.4
	300	0.09	28.5
	360	0.08	30.7
	400	0.08	32.2

1) Calculation with 10 % wood content

2) Execution in accordance with inspection certificate P-SAC-02/III-321

3. Lightweight partition walls

3.1 Timber upright construction



3.1.1 Single-panelled on both sides

Structure:

- Single panelling
- **GUTEX Thermosafe®/Thermoflex®*/Thermofibre®²⁾** between timber uprights
- Single panelling

Panelling (mm)	Deep timber uprights (mm)	GUTEX Thermosafe® (mm)	U-factor ¹⁾ (W/m ² K)	Noise insulation value R _w (dB)
OSB board 15	60	40	0.64	37
	140	140	0.28	40
OSB board 15	140	120	0.30	40
Plasterboard 12.5	60	40	0.70	42
Plasterboard 12.5				
Fibre reinforced plasterboard 12.5	60	60	0.60	47
Fibre reinforced plasterboard 12.5	140	140	0.29	48



3.1.2 Double-panelled on one side; single-panelled on one side

Structure:

- Double panelling
- **GUTEX Thermosafe®/Thermoflex®*/Thermofibre®²⁾** between timber uprights
- Single panelling

Panelling (mm)	Deep timber uprights (mm)	GUTEX Thermosafe® (mm)	U-factor ¹⁾ (W/m ² K)	Noise insulation value R _w (dB)
Plasterboard 9.5	60	40	0.68	45
Plasterboard 12.5				
Plasterboard 12.5				
Fibre reinforced plasterboard 10	60	60	0.59	50
Fibre reinforced plasterboard 12.5				
Fibre reinforced plasterboard 12.5	140	140	0.29	50



3.1.3 Double-panelled on both sides

Structure:

- Double panelling
- **GUTEX Thermosafe®/Thermoflex®*/Thermofibre®²⁾** between timber uprights
- Double panelling

Panelling (mm)	Deep timber uprights (mm)	GUTEX Thermosafe® (mm)	U-factor ¹⁾ (W/m ² K)	Noise insulation value R _w (dB)
Plasterboard 9.5	60	40	0.66	47
Plasterboard 12.5				
Plasterboard 12.5				
Plasterboard 9.5				
Plasterboard 9.5	60	40	0.61	47
OSB board 15				
Plasterboard 9.5				
Fibre reinforced plasterboard 10	140	120	0.29	51
OSB board 15				
OSB board 15	60	60	0.58	52
Fibre reinforced plasterboard 10				
Fibre reinforced plasterboard 12.5				
Fibre reinforced plasterboard 12.5	140	140	0.29	52
Fibre reinforced plasterboard 10				

* The stated noise values can be up to 3 dB worse when using GUTEX Thermoflex
 1) Calculation with 10 % wood content
 2) There are still no noise values for constructions using GUTEX Thermofibre

3. Lightweight partition walls

3.2 Metal upright construction



3.2.1 Single-panelled on both sides

Structure:

- Panelling
- **GUTEX Thermosafe/-homogen**® between metal uprights
- Panelling

Panelling (mm)	Deep metal uprights (mm)	GUTEX Thermosafe® (mm)	U-factor (W/m²K)	Noise insulation value R _w (dB)
Plasterboard 12.5	75	40	1.21	47
Plasterboard 12.5	125	100	0.90	49



3.2.2 Double-panelled on both sides

Structure:

- Double panelling
- **GUTEX Thermosafe/-homogen**® between metal uprights
- Double panelling

Panelling (mm)	Deep metal uprights (mm)	GUTEX Thermosafe® (mm)	U-factor (W/m²K)	Noise insulation value R _w (dB)
Plasterboard 9.5 Plasterboard 12.5	125	100	0.79	54
Plasterboard 12.5 Plasterboard 9.5				
Fibre reinforced plasterboard 10 Fibre reinforced plasterboard 12.5	50	40	1.17	55
Fibre reinforced plasterboard 12.5 Fibre reinforced plasterboard 10	125	100	0.84	62

4. Concrete ceiling

New build and reconstruction

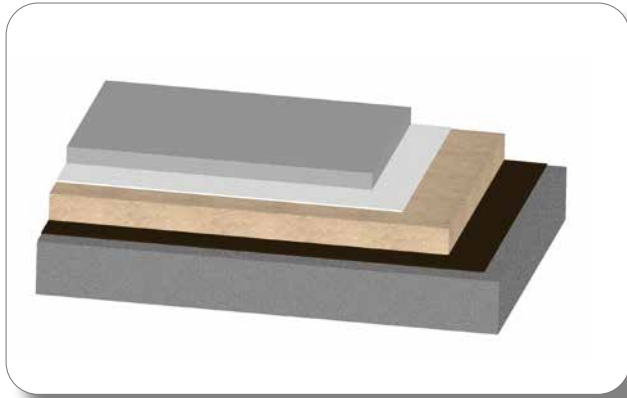

4.1 Cement screed

Structure:

- Cement screed 50 mm
- Moisture proofing membrane
- **GUTEX insulating layer**
- Moisture barrier to DIN 18195
- Concrete ceiling 140 mm

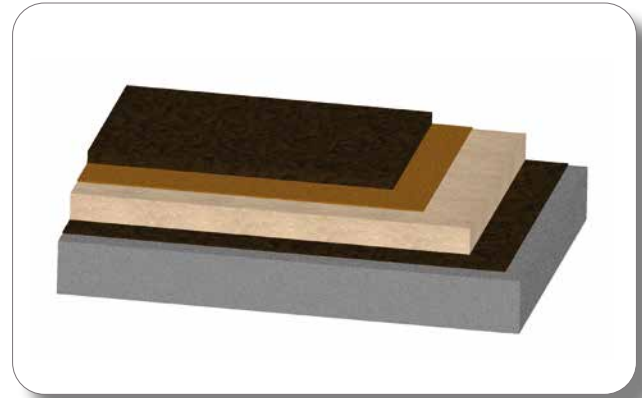

4.2 Mastic asphalt

Structure:

- Mastic asphalt 30 mm
- Corrugated cardboard 2.5 mm
- **GUTEX insulating layer**
- Moisture barrier to DIN 18195
- Concrete ceiling 140 mm

	Insulating layer (mm)	Installation height (mm)	U-factor (W/m ² K)	Standard impact noise level L _{nw} (dB)	Impact sound attenuation ΔL _w (dB)
GUTEX Thermosafe- wd®	40	90	0.68		
	60	110	0.51		
	80	130	0.40		
	100	150	0.33		
	120	170	0.28		
	140	190	0.25		
GUTEX Thermofloor®	20	70	1.05	55	24
	30	80	0.83	54	24
	2x20	90	0.68	≥ 55	≥ 24
	2x30	110	0.51	≥ 54	≥ 25
	20 + 30	100	0.58	≥ 55	≥ 24

	Insulating layer (mm)	Installation height (mm)	U-factor (W/m ² K)	Standard impact noise level L _{nw} (dB)	Impact sound attenuation ΔL _w (dB)
GUTEX Thermosafe- wd®	40	75	0.69		
	60	95	0.51		
	80	115	0.40		
	100	135	0.33		
	120	155	0.28		
	140	175	0.25		
GUTEX Thermofloor®	20	55	1.06	51*	23
	30	65	0.83	54	28
	2x20	75	0.69		
	2x30	95	0.51		
	20+ 30	85	0.58		

* In combination with 30 mm of perlite ballast below the GUTEX Thermofloor

4. Concrete ceiling

New build and reconstruction

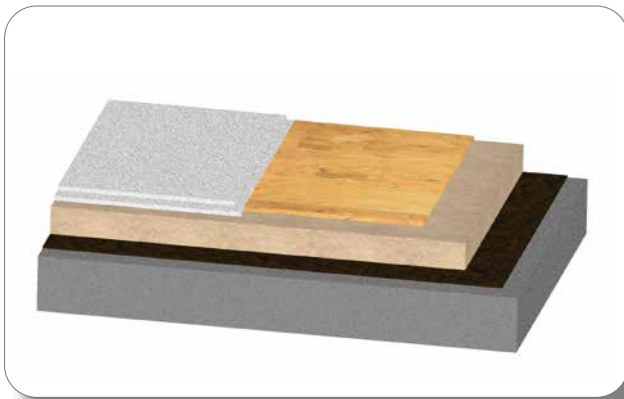

4.3 Sill plate/dry screed element

Structure:

- Sill plate/dry screed element *
- **GUTEX insulating layer**
- Moisture barrier to DIN 18195
- Concrete ceiling 140 mm

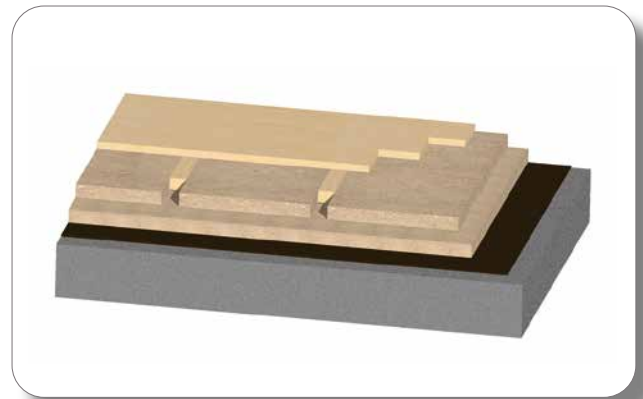

4.4 Solid wooden floor

Structure:

- Solid wooden floor min. 19 mm
- **GUTEX Thermosafe-nf 40 mm**
- **GUTEX insulating layer**
- Moisture barrier to DIN 18195
- Concrete ceiling 140 mm

	Insulating layer (mm)	Installation height (mm)	U-factor (W/m ² K)	Standard impact noise level L _{nw} (dB)	Impact sound attenuation ΔL _w (dB)
GUTEX Thermosafe-wd®	20	45	0.92		
	30	55	0.75	48*	
	40	65	0.63		
	60	85	0.47		
	80	105	0.38		
	100	125	0.32		
	120**	145	0.27		
GUTEX Thermofloor®	20	45	0.92		
	30**	55	0.75		

	Insulating layer (mm)	Installation height (mm)	U-factor (W/m ² K)	Standard impact noise level L _{nw} (dB)	Impact noise attenuation ΔL _w (dB)
GUTEX Standard-n®	8	68	0.55	52	26
GUTEX Thermosafe-wd®	20	80	0.47		
	30	90	0.42		
	40	100	0.38		
	60	120	0.32		
	80	140	0.27		
	100	160	0.24		

* Sill plates: OSB min. 22 mm; particleboard min. 25 mm; dry screed element min. 25 mm

** only in combination with sill plates in accordance with technical datasheet

5. Beamed ceiling

New build and reconstruction



Bare ceiling 1

Structure:

- Wooden floor/exposed formwork, bolted
- Beam position 220/60 mm,
- Grid 62.5 cm

Standard impact noise level L _{nw} (dB)	Assessed noise insulation R _w
91	24



Raw ceiling 2

Structure:

- Wooden floor/exposed formwork, bolted
- Beam position 220/60 mm, grid 62.5 cm
- Cavity insulation 100 mm*
- Bay insert: sprung rod fastened to battens
- PBP 12.5 mm, bolted (clearance between bottom edge of battens to top edge of panelling 100 mm, grid FS 41.5 cm)

Standard impact noise level L _{nw} (dB)	Assessed noise insulation R _w
71	42



Raw ceiling 3

Structure:

- FPY 25 mm bolted
- Beam position 220/60 mm, grid 62.5 cm
- Cavity insulation 100 mm*
- Battens, grid 41.5 cm bolted
- PBP 12.5 mm, bolted

Standard impact noise level L _{nw} (dB)	Assessed noise insulation R _w
75	45

* e.g. GUTEX Thermoflex

5. Beamed ceiling

New build and reconstruction

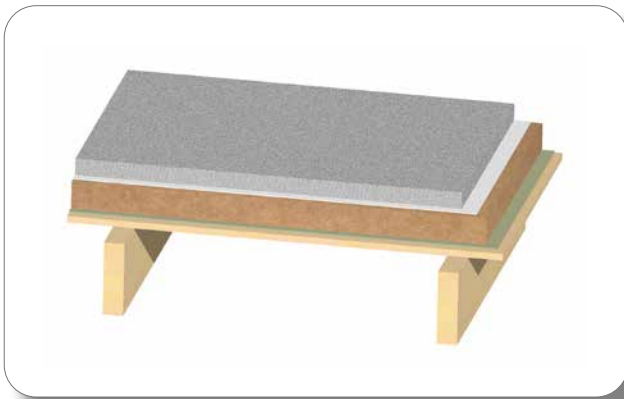

5.1.1 Cement screed, open beam position

Structure:

- Cement screed 50 mm
- Moisture proofing membrane
- **GUTEX insulating layer**
- Drip strip
- Exposed formwork
- Raw ceiling 1 (see page 40)

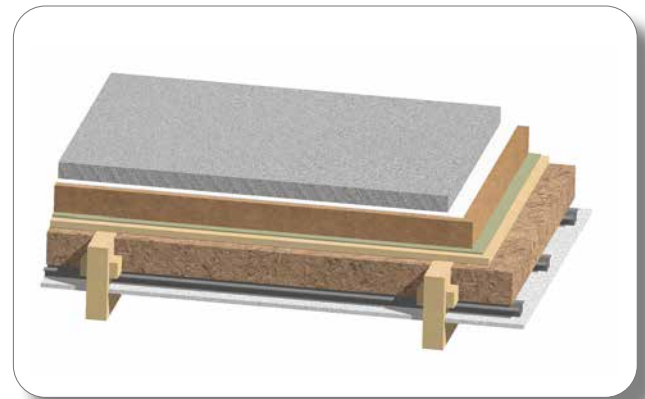

5.1.2 Cement screed, semi-open beam position

Structure:

- Cement screed 50 mm
- Moisture proofing membrane
- **GUTEX insulating layer**
- Drip strip
- Exposed formwork
- Raw ceiling 2 (see page 40)

	Insulating layer (mm)	Installation height (mm)	U-factor (W/m ² K)	Standard impact noise level L _{nw} (dB)	Impact noise attenuation ΔL _{w,H} (dB)
GUTEX Thermosafe-wd®	40	90	0.64		
	60	110	0.48		
	80	130	0.38		
	100	150	0.32		
	120	170	0.28		
	140	190	0.24		
GUTEX Thermofloor®	20	70	0.94		
	30	80	0.76	79	10
	2x20	90	0.64		
	2x30	110	0.48		
	20+ 30	100	0.55	75	10

	Insulating layer (mm)	Installation height (mm)	U-factor (W/m ² K)	Standard impact noise level L _{nw} (dB)	Impact noise attenuation ΔL _{w,H} (dB)
GUTEX Thermosafe-wd®	40	90	0.25		
	60	110	0.22		
	80	130	0.20		
	100	150	0.18		
	120	170	0.17		
	140	190	0.15		
GUTEX Thermofloor®	20	70	0.29	50*	11*
	30	80	0.27		
	2x20	90	0.25	48*	15*
	2x30	110	0.22		
	20+ 30	100	0.24		

* In combination with 50 mm of limescale ballast below GUTEX Thermofloor

5. Beamed ceiling

New build and reconstruction

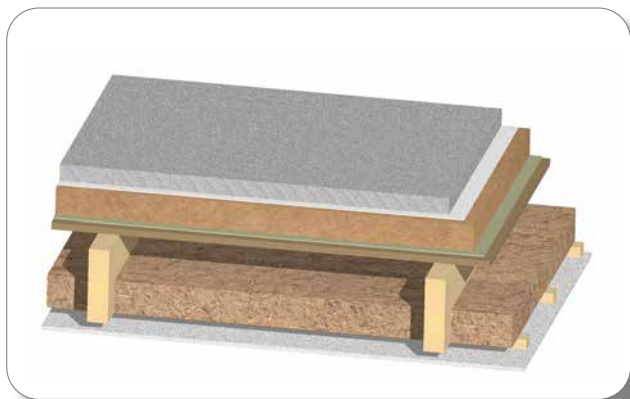

5.1.3 Cement screed, closed beam position

Structure:

- Cement screed 50 mm
- Moisture proofing membrane
- **GUTEX insulating layer**
- Drip strip
- Raw ceiling 3 (see page 40)



5.2.1 Mastic asphalt, open beam position

Structure:

- Mastic asphalt 35 mm
- Titacord corrugated cardboard 2.5 mm
- **GUTEX insulating layer**
- Drip strip
- Raw ceiling 1 (see page 40)

	Insulating layer (mm)	Installation height (mm)	U-factor (W/m ² K)	Standard impact noise level L _{nw} (dB)	Impact noise attenuation ΔL _{w,H} (dB)
GUTEX Thermosafe-wd®	40	90	0.24		
	60	110	0.21		
	80	130	0.19		
	100	150	0.18		
	120	170	0.16		
GUTEX Thermofloor®	140	190	0.15		
	20	70	0.27	62*	11*
	30	80	0.26		
	2x20	90	0.24		
	2x30	110	0.21	60 (48*)	15
	20 + 30	100	0.23		

* Bottom layer: 2x PBP 12.5 mm on sprung rod

	Insulating layer (mm)	Installation height (mm)	U-factor (W/m ² K)	Standard impact noise level L _{nw} (dB)	Impact noise attenuation ΔL _{w,H} (dB)
GUTEX Thermosafe-wd®	40	78	0.63		
	60	98	0.48		
	80	108	0.38		
	100	128	0.32		
	120	148	0.28		
GUTEX Thermofloor®	140	168	0.24		
	20	58	0.94	≥ 76 ¹⁾	15 ¹⁾
	30	68	0.76	≥ 76 ¹⁾	15 ¹⁾
	2x20	78	0.63	≥ 74 ¹⁾	17 ¹⁾
	2x30	98	0.48	≥ 74 ¹⁾	17 ¹⁾
	20+30	88	0.55	≥ 74 ¹⁾	17 ¹⁾

1) Calculated in accordance with wood information service, series 3 edition, part 3, sequence 3

5. Beamed ceiling

New build and reconstruction

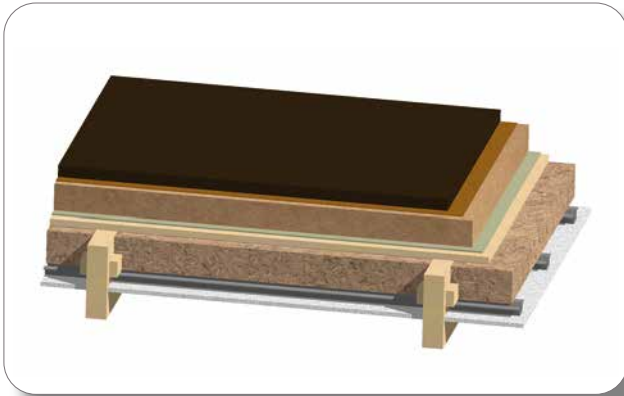

5.2.2 Mastic asphalt, semi-open beam position

Structure:

- Mastic asphalt 35 mm
- Titacord corrugated cardboard 2.5 mm
- **GUTEX insulating layer**
- Drip strip
- Raw ceiling 2 (see page 40)



5.2.3 Mastic asphalt, closed beam position

Structure:

- Mastic asphalt 35 mm
- Titacord corrugated cardboard 2.5 mm
- **GUTEX insulating layer**
- Drip strip
- Raw ceiling 3 (see page 40)

	Insulating layer (mm)	Installation height (mm)	U-factor (W/m ² K)	Standard impact noise level L _{nw} (dB)	Impact noise attenuation ΔL _{w,H} (dB)
GUTEX Thermosafe-wd®	40	78	0,25		
	60	98	0,22		
	80	108	0,21		
	100	128	0,18		
	120	148	0,17		
	140	168	0,15		
GUTEX Thermofloor®	20	58	0,29	≥ 57 ¹⁾	15 ¹⁾
	30	68	0,27	≥ 57(48*) ¹⁾	15 ¹⁾
	2x20	78	0,25	≥ 54 ¹⁾	17 ¹⁾
	2x30	98	0,22	≥ 54 ¹⁾	17 ¹⁾
	20 + 30	88	0,24	≥ 54 ¹⁾	17 ¹⁾

* Only in combination with 50 mm of limescale ballast below the GUTEX Thermofloor

1) Calculated in accordance with wood information service, series 3 edition, part 3, sequence 3

	Insulating layer (mm)	Installation height (mm)	U-factor (W/m ² K)	Standard impact noise level L _{nw} (dB)	Impact noise attenuation ΔL _{w,H} (dB)
GUTEX Thermosafe-wd®	40	78	0.24		
	60	98	0.21		
	80	108	0.19		
	100	128	0.18		
	120	148	0.16		
	140	168	0.15		
GUTEX Thermofloor®	20	58	0.27	≥ 57 ¹⁾	15 ¹⁾
	30	68	0.26	57 (48*)	14**
	2x20	78	0.24	≥ 57 ¹⁾	17 ¹⁾
	2x30	98	0.21	≥ 57 ¹⁾	17 ¹⁾
	20 + 30	88	0.23	≥ 57 ¹⁾	17 ¹⁾

* Only in combination with 50 mm of limescale ballast below GUTEX Thermofloor

** only if PBP is mounted to sprung rod

1) Calculated in accordance with wood information service, series 3 edition, part 3, sequence 3

5. Beamed ceiling

New build and reconstruction



5.3.1 Sill plate/dry screed element

Structure:

- Sill plate/dry screed element
- **GUTEX insulating layer**
- Drip strip
- Raw ceiling 1 (see page 40)

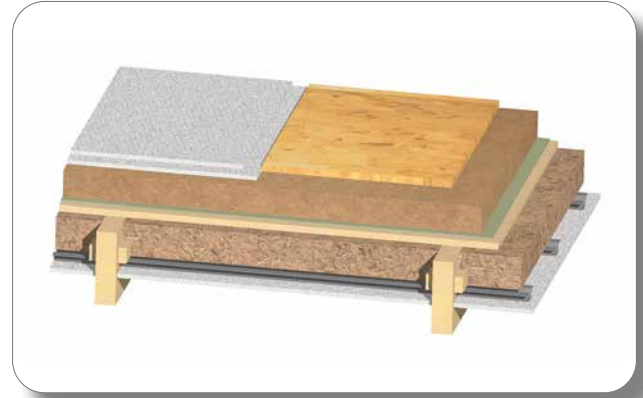

5.3.2 Sill plate/dry screed element

Structure:

- Sill plate/dry screed element
- **GUTEX insulating layer**
- Drip strip
- Raw ceiling 2 (see page 40)

	Insulating layer (mm)	Installation height (mm)	U-factor (W/m ² K)	Standard impact noise level L _{nw} (dB)	Impact noise attenuation ΔL _{w,H} (dB)
GUTEX Thermosafe- wd®	20	45	0.82		
	30	55	0.68		
	40	65	0.58		
	60	85	0.45		
	80	105	0.36		
	100	125	0.31		
	120	145	0.26		
GUTEX Thermofloor®	20	45	0.82		
	30	55	0.68		6 ¹⁾

	Insulating layer (mm)	Installation height (mm)	U-factor (W/m ² K)	Standard impact noise level L _{nw} (dB)	Impact noise attenuation ΔL _{w,H} (dB)
GUTEX Thermosafe- wd®	20	45	0.28		
	30	55	0.26		
	40	65	0.25		
	60	85	0.22		
	80	105	0.20		
	100	125	0.18		
	120	145	0.16		
GUTEX Thermofloor®	20	45	0.28	50**	9**
	30	55	0.26	≥ 65 ¹⁾	6 ¹⁾

** Only in combination with a 25 mm dry screed element from Fermacell and if limescale ballast is 50 mm

1) Calculated in accordance with wood information service, series 3 edition, part 3, sequence 3

5. Beamed ceiling

New build and reconstruction

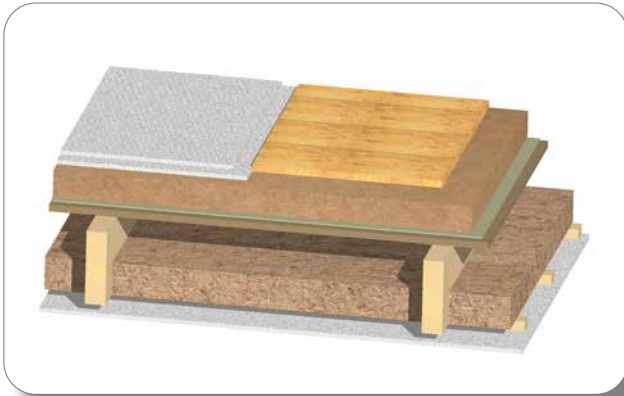

5.3.3 Sill plate/dry screed element

Structure:

- Sill plate/dry screed element
- **GUTEX insulating layer**
- Drip strip
- Raw ceiling 3 (see page 40)



5.4.1 Solid wooden floor

Structure:

- Wooden floor min. 19 mm
- **GUTEX Thermosafe-nf 40 mm**
- **GUTEX insulating layer**
- Drip strip
- Raw ceiling I (see page 40)

	Insulating layer (mm)	Installation height (mm)	U-factor (W/m ² K)	Standard impact noise level L _{nw} (dB)	Impact noise attenuation ΔL _{wH} (dB)
GUTEX Thermosafe-wd®	20	45	0.26		
	30	55	0.25	65*	
	40	65	0.23		
	60	85	0.21		
	80	105	0.19		
	100	125	0.17		
	140	145	0.16		
GUTEX Thermofloor®	20	45	0.26	67*	
	30	55	0.25	≥ 69 ¹⁾	6 ¹⁾

* Only in combination with a 25 mm dry screed element from Fermacell

1) Calculated in accordance with wood information service, series 3 edition, part 3, sequence 3

	Insulating layer (mm)	Installation height (mm)	U-factor (W/m ² K)	Standard impact noise level L _{nw} (dB)	Impact noise attenuation ΔL _{wH} (dB)
GUTEX Standard-n®	8	67	0.54		11
GUTEX Thermosafe-wd®	20	79	0.46	57**	
	30	89	0.41		
	40	99	0.37		
	60	119	0.31		
	80	139	0.27		
	100	159	0.24		

** Only in combination with 60 mm of limescale ballast below the GUTEX Thermosafe-wd

5. Beamed ceiling

New build and reconstruction

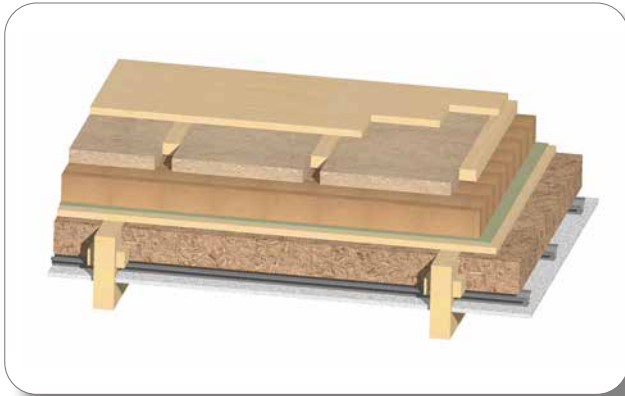

5.4.2 Solid wooden floor, semi-open beam position

Structure:

- Wooden floor min. 19 mm
- **GUTEX Thermosafe-nf 40 mm**
- **GUTEX insulating layer**
- Drip strip
- Raw ceiling 2 (see page 40)



5.4.3 Solid wooden floor, closed beam position

Structure:

- Wooden floor min. 19 mm
- **GUTEX Thermosafe-nf 40 mm**
- **GUTEX insulating layer**
- Drip strip
- Raw ceiling 3 (see page 40)

	Insulating layer (mm)	Installation height (mm)	U-factor (W/m ² K)	Standard impact noise level L _{nw} (dB)	Impact noise attenuation ΔL _{w,H} (dB)
GUTEX Standard-n®	8	67	0.24		
GUTEX Thermosafe-wd®	20	79	0.22	49*	
	30	89	0.21		
	40	99	0.20		
	60	119	0.18		
	80	139	0.16		
	100	159	0.15		

* Only in combination with 60 mm of limescale ballast below the GUTEX Thermosafe-wd

	Insulating layer (mm)	Installation height (mm)	U-factor (W/m ² K)	Standard impact noise level L _{nw} (dB)	Impact noise attenuation ΔL _{w,H} (dB)
GUTEX Standard-n®	8	67	0.23	48*	11*
GUTEX Thermosafe-wd®	20	79	0.21		
	30	89	0.20		
	40	99	0.19		
	60	119	0.17		
	80	139	0.17		
	100	159	0.15		

* Bottom layer: 2 x plasterboard 12.5 mm on sprung rod

6. Top floor ceiling

New build and reconstruction

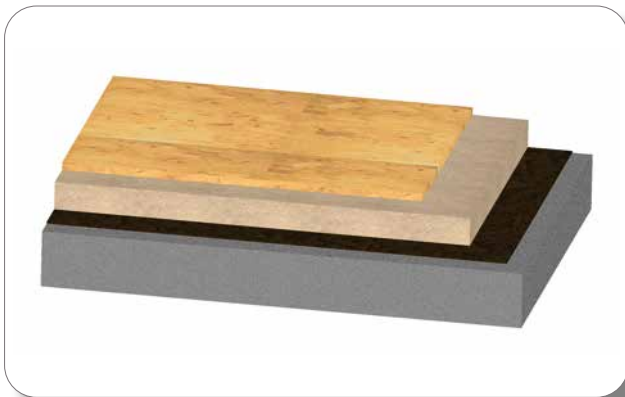

6.1 Concrete ceiling, non-insulated

Structure:

- Sill plate min. 13 mm
- **GUTEX Thermosafe-homogen**
- Moisture barrier to DIN 18195
- Concrete ceiling 140 mm

	Insulating layer (mm)	U-factor (W/m ² K)	Phase shift (h)
GUTEX Thermosafe-homogen®	160	0.21	13.5
	180	0.19	14.6
	200	0.17	15.8
	220	0.16	17.0
	240	0.15	18.1

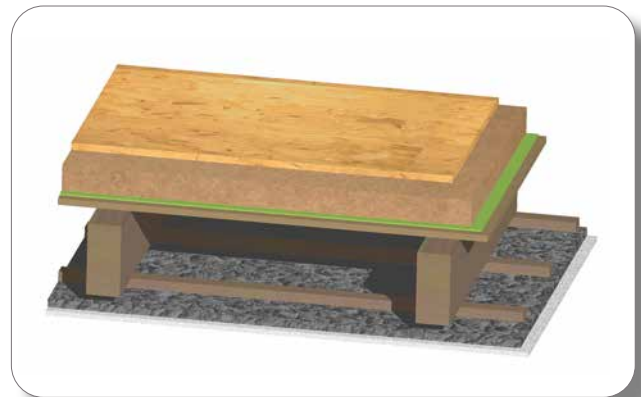

6.2 Beamed ceiling, closed, non-insulated

Structure:

- Sill plate min. 13 mm
- **GUTEX Thermosafe-homogen**
- Vapour barrier/air seal
- Existing board panelling/sill plate
- Existing beam position, non-insulated
- Existing HWL board, plastered

	Insulating layer (mm)	U-factor (W/m ² K)	Phase shift (h)
GUTEX Thermosafe-homogen®	140	0.21	14.2
	160	0.19	15.3
	180	0.17	16.5
	200	0.15	17.6
	220	0.14	18.8
	240	0.13	19.9



6.3 Beamed ceiling, closed, partially insulated

Structure:

- Sill plate min. 13 mm
- **GUTEX Thermosafe-homogen**®
- Vapour barrier/air seal
- Existing board panelling/sill plate
- Existing beam position
- Existing cavity insulation 100 mm
- Existing HWL board, plastered 30 mm

	Insulating layer (mm)	U-factor (W/m ² K)	Phase shift (h)
GUTEX Thermosafe-homogen®	100	0.17	16.2
	120	0.15	17.3
	140	0.14	18.4
	160	0.13	19.6
	180	0.12	20.7
	200	0.11	21.9
	220	0.11	23.0
	240	0.10	24.2

Use of the insulated top floor ceiling in combination with Thermosafe-homogen is not suitable for residential purposes.



Insulation against the heat in summer

GUTEX wood insulation boards protect living areas from high temperatures, in particular, areas under roofs. Thanks to their high thermal storage capacity, they effectively dampen the flow of warmth from exterior to interior areas. Wood has a specific thermal storage capacity of 2100 J/kgK, which is the highest amongst all insulation materials.



Insulation against the cold in winter

Effective insulation reduces heating bills and creates a comfortable living environment in winter. Due to their low thermal conductivity ($\lambda_D = 0.037 \text{ W/mK}$), GUTEX insulating wood fibreboards provide optimum insulation in winter, protecting the interior of houses from heat loss and ingress of cold.



Pleasant indoor environment

GUTEX wood fibre insulation boards are vapour permeable ($\mu = 3$), regulating the living environment with their ability to absorb and release up to 15 % of their weight in moisture without the loss of their insulation capacity.



Acoustic insulation

The open-pore structure of GUTEX wood fibreboards and their high absorption volume contribute to their ability to deliver superb soundproofing against airborne and impact noise.



Fire protection

GUTEX wood fibre insulation boards easily comply with fire protection regulations. Various individual certificates of approval are available for F30-B to F90-B fire resistance ratings for roof and wall structures.



Environmental compatibility

The raw material for all GUTEX insulation boards comes from wood that is locally harvested and

grown using sustainable forestry management practices. GUTEX exclusively uses untreated spruce and fir chips and shavings, which are by-products obtained from other timber manufacturing processes. All GUTEX insulation boards are tested and certified as biologically safe and compatible with other building materials (natureplus® seal of quality).



Recyclability

GUTEX wood fibreboards are completely recyclable and, provided wood preservatives have not contaminated them, can be disposed of at the nearest recovery centre.



User friendly

GUTEX insulation boards are manufactured according to the highest quality standards and are characterised by absolutely minimum dimensional deviation. This, combined with the detailed installation instructions provided by the manufacturer, makes working with GUTEX products a pleasure.



Made in Germany

For more than 80 years, GUTEX, a family owned and operated company, has manufactured insulation boards at its plant in Waldshut-Tiengen, which is located in the southern Black Forest. All GUTEX insulation boards carry the CE marks and are produced according to the current applicable standards. GUTEX's external thermal insulation system (ETICS) is approved by the German building authorities.

GUTEX customer service

An important part of GUTEX's customer service is its qualified assistance. Whether you require help with a private single-family house or commercial property, GUTEX's trained and qualified staff will gladly assist you. If you have technical queries, please contact our technical assistance department by phone +49-7741/60 99-125, fax +49-7741/60 99-21 or per e-mail at anwendungstechnik@gutex.de.

GUTEX product training

Architects, craftsmen, wholesalers, sales staffs and developers can benefit from the workshops GUTEX offers, which address specific topics, including physics and building, construction techniques, product applications, etc. Visit our Web site for further information or give us a call.

Your stockist / Advisor:

